

Final Report

City of Salinas

Neighborhood Traffic Management Program

TRANSPORTATION



& PLANNING



FEHR & PEERS
TRANSPORTATION CONSULTANTS

160 W. Santa Clara St., Ste. 675
San Jose, CA 95113

SJ07-905

November 2008

Final Report

**City of Salinas
Neighborhood Traffic
Management Program**

Prepared For:

City of Salinas

Prepared By:

Fehr & Peers

November 2008

TABLE OF CONTENTS

<u>SECTION</u>	<u>PAGE</u>
1. Introduction	1
Purpose	1
Overview	1
NTMP Development.....	2
Funding	3
How To Use This Document.....	3
Who to Contact	3
2. Process Framework.....	5
Plan Initiation.....	5
Plan Development.....	9
Neighborhood Support.....	11
Plan Implementation	13
Process for Removal.....	14
3. Toolbox	16
Non-Physical Devices	17
Speed Control – Narrowing Devices.....	23
Speed Control – Horizontal Devices.....	28
Speed Control – Vertical Devices	34
Volume Control – Devices	43
4. Toolbox Guidelines.....	50
Guidelines	50
Effectiveness Comparison	51
Placing the Neighborhood Traffic Management Measures.....	51
5. New Development Guidelines.....	59
Suggested Development Review Process.....	59
Development Review Practices	61
Designing Street Networks	61
Designing for Appropriate Speeds	62
Designing for Local Traffic	63
Pedestrian/Vehicle Conflict Areas.....	63
Developing a Neighborhood Traffic Management Plan	64
Appendix A – Design Guidelines	A-1
Speed Control – Vertical Measures	A-1
Horizontal Deflection Measures	A-3
Narrowing Measures	A-4
Landscaping.....	A-5
Signage and Striping.....	A-6
Combined Measures	A-6
Appendix B – Standard Traffic Calming Templates.....	B-1
Appendix C – City of Salinas Pedestrian Safety Enhancement Devises Policy	C-1
Appendix D – City of Salinas Primary Fire Response Routes	D-1

LIST OF TABLES

<u>SECTION</u>		<u>PAGE</u>
Table 1	Applicability of Treatments by Traffic Related Concern.....	52
Table 2	Applicability of Treatments by Location	53
Table 3	Applicability by Street Type.....	54
Table 4	Quantitative Impacts of Neighborhood Traffic Management Measures	56

LIST OF FIGURES

<u>SECTION</u>	<u>PAGE</u>
Figure 1	NTMP Process Framework..... 6
Figure 2	NTMP Process For Removal 15
Figure 3	Estimating Midpoint Speed 57
Figure 4	New Development Review Process..... 60
Figure 5	Correlation Between Pavement Width, Unimpeded Street Length and Speed 63
Figure A-1	Vertical Measure Ramp Profiles A-1
Figure A-2	Traffic circles at T-Intersections A-4
Figure A-3	Common Warning Signs A-7
Figure B-1A	Speed Hump – Parabolic Profile..... B-2
Figure B-1B	Speed Hump – Sinusoidal Profile B-3
Figure B-2	Speed Lump..... B-4
Figure B-3	Speed Table..... B-5
Figure B-4	Raised Crosswalk B-6
Figure B-5	Raised Intersection B-7
Figure B-6	Vertical Device – Advance Warning Markings..... B-8
Figure B-7	Neckdown/Bulbout – Intersection B-9
Figure B-8	Neckdown/Bulbout – Midblock..... B-10
Figure B-9	Center Island Narrowing B-11
Figure B-10	Two-lane Choker..... B-12
Figure B-11	Traffic Circle B-13
Figure B-12	Chicane B-14
Figure B-13	Partial Closure..... B-15
Figure B-14	Diagonal Diverter B-16
Figure B-15	Median Barrier..... B-17
Figure B-16	Forced Turn Island..... B-18
Figure D-1	City of Salinas Primary Fire Response Routes..... D-2

ACKNOWLEDGMENTS

Robert Russell, P.E. City Deputy/Engineer City Manager, City of Salinas

James Serrano, Transportation Planner, Development and Engineering Services Department, City of Salinas

1. INTRODUCTION

PURPOSE

Growth in traffic volumes in Salinas and the broader region has increased the frequency and severity of traffic-related issues on neighborhood streets. Numerous agencies across the nation have confronted these problems using a proven process and tools to address both safety and quality-of-life concerns. The process is known as a Neighborhood Traffic Management Program (NTMP), which uses traffic calming tools and techniques.

The purpose of this document is to define a NTMP that is customized to the needs and unique characteristics of Salinas residential streets.

OVERVIEW

As defined in an *ITE Journal* article, “[t]raffic calming is the combination of mainly physical measures that reduce the negative effects of motor vehicle use, alter driver behavior and improve conditions for non-motorized street users.”¹ This definition suggests that the negative effects of vehicle speeds and/or excessive traffic volumes on neighborhood streets can diminish the residential quality of life. While residential life “quality” is subjective, vehicle speeds and traffic volumes can be quantified and compared against adopted community or industry standards. Experiences reinforce this notion as some community residents embrace traffic calming, while others are not so willing to accept the inconveniences of “managed traffic” in lieu of a perceived improvement in residential quality of life.

With this in mind, the Development and Engineering Services (DES) Department has requested assistance with preparation of a comprehensive program that includes a systematic approach to handling neighborhood traffic requests, and applying the most appropriate traffic calming measures for the situation at hand. The NTMP will also engage community residents during the development of individual neighborhood traffic calming plans and determine local support for the plan through neighborhood participation.

The process defined herein is intended solely for use on public streets and is not applicable to non-City maintained roadways (i.e., private roads, or county roadways). However, use of this manual as a guideline for non-City roadways, will require oversight by the Fire Department on the planning, design, and implementation of such features. Eligible City maintained roadways (i.e., public roads) include two-lane local, collector, and some minor arterials located within the City limits.

The terms “local” and “collector” streets refer to the functional classification that denotes a specific level in the transportation network hierarchy and specifies the design according to City of Salinas standards. While the streets may have been designed for a particular purpose, they may function differently in the field than intended. Therefore, it may be difficult to differentiate between the two classifications. Following is a narrative description of each roadway classification:

- Local Streets provide direct access to residential properties and facilitate short neighborhood trips. Typical local street features include:
 - Two-lane 24- to 34-foot travel way width (curb face to curb face)

¹ Lockwood, I.M., “ITE Traffic Calming Definition.” *ITE Journal*, Vol. 67, July 1997, pp. 22-24.

- Serves fewer than 75 residential units on a through cul-de-sac or street
- Collector Streets are secondary roads that connect motorists from surrounding local streets to arterial roadways and freeways and facilitate intermediate trip lengths. Typical collector street features include:
 - 34- to 40-foot travel way
 - Connects local streets to arterials
 - May or may not include front-on housing

The underpinnings of the NTMP are based on a combination of parallel strategies, known collectively as the “Three E’s”:

- Education – Providing information and raising awareness; targeting drivers, pedestrians, and cyclists about the safest and best ways to share the road.
- Engineering – Physical measures constructed to lower speeds, improve safety, or otherwise reduce the impacts of automobiles, on residents and other transportation modes.
- Enforcement – Targeted enforcement by the City of Salinas Police Department to reinforce the emphasis on education and engineering aspects of the program.

This document focuses on the engineering aspects of neighborhood traffic calming, though education and enforcement play an important role in any engineering strategy. This document and informational flyers provide education, while the City of Salinas Police Department, Monterey County Sheriff Department, and California Highway Patrol conduct targeted speed enforcement. Although targeted speed enforcement provides a positive influence on neighborhood streets, the demand for this service can easily outstrip the resources of any enforcement agency. Therefore, neighborhood traffic calming is a viable alternative that is typically self-enforcing and minimizes operating costs.

This program also considers the roadway network and design of new developments. Developers, with guidance from DES staff, can reduce the need for future traffic calming by designing new streets that discourage speeding and cut-through traffic. To supplement these design principles, developers can incorporate traffic calming concepts and measures as part of the initial development.

NTMP DEVELOPMENT

This manual was adapted to meet the needs of the City of Salinas. An advisory committee composed of representatives from City of Salinas Planning, Engineering, and Traffic Divisions; Salinas Fire Districts, Salinas Police Department; Monterey Salinas Transit; City Council Districts, and local agencies and interested parties convened to review material and provide input on specific aspects of the NTMP process framework and toolbox.

The material presented to the TAC was based on a 2004 national survey conducted of 21 leading jurisdictions’ traffic calming practices. The survey provided insight into the evolution of the traffic calming field since the last in-depth report² almost a decade ago. The various approaches, policies, and uses of traffic

² Ewing, R. *Traffic Calming State-of-the-Practice*. Washington, D.C., USA: Institute of Transportation Engineers /Federal Highway Administration, 1999.

calming devices reported in this survey provided a menu of alternatives to develop a Neighborhood Traffic Management Program unique to the City of Salinas.

FUNDING

Funding for the Salinas NTMP will likely come from the City's limited street funding, which will compete annually for funding amongst other programs. Funding will go towards staff time (operating cost) and construction costs (capital cost) of standard devices. As DES identifies needs in the next fiscal budget, City staff and decision-makers may recognize that other funding sources may be necessary to maintain the program or meet the anticipated demand. To offset the public demand and stretch the funding, residents will be required to contribute 75 percent of the costs for speed humps (or other vertical devices). Additional cost sharing may be necessary depending on annual funding and level of public demand. The need and proportional share to residents will be determined annually.

In the absence of funding or to expedite treatment, residents may elect to fund a local traffic calming plan. The neighborhood must prove the financial ability to fund 100 percent of the anticipated costs, which include plan development, engineering drawings, and construction. Upon proof of financial ability, DES can elect to authorize the neighborhood's request to develop a traffic calming plan. Regardless of resident contributions, physical measures will be implemented only if warranted through an engineering study or as part of another City sponsored project (e.g., a streetscape plan).

In addition, residents could voluntarily elect to fund aesthetic upgrades to the standard devices. Such aesthetic upgrades could include landscaping or use of decorative materials.

HOW TO USE THIS DOCUMENT

This document provides guidelines, not rigid requirements. These guidelines are primarily intended for DES staff and residents to help develop an appropriate NTMP, and for builders and staff to create and review new subdivision plans.

This manual will likely evolve as staff and community members work through the program; and identify more efficient or different methods of implementing the program and better ways of disseminating information. DES staff may also revise the design guidelines and cost estimates to ensure updated material is presented.

WHO TO CONTACT

To find out more information about the Neighborhood Traffic Management Program or whether your street is eligible for traffic calming, please contact:

- The Traffic and Transportation Division of the Development and Engineering Services Department at (831) 758-7241 or deveng@ci.salinas.ca.us.

HOW TO USE THIS DOCUMENT

If you are a Resident, you should focus on the following chapters:

Chapter 2, Process Framework, to find out how to request traffic calming on your street and the steps necessary to implement a traffic calming plan.

Chapter 3, Toolbox, to discover what particular traffic calming devices are available and the advantages and disadvantages of each.

If you are an Engineer/Planner involved in the development of a new subdivision, you should focus on the following chapters:

Chapters 3 and 4, Toolbox and Toolbox Guidelines, to discover what devices you can incorporate into your development.

Chapter 5, New Development Guidelines, for techniques to minimize the potential for future speeding and traffic-related concerns.

DES staff members should focus on the above Chapters as well as the following appendices:

Appendix A – Design Guidelines provides recommended design features to minimize design issues once implemented.

Appendix B – Standard Traffic Calming Templates provides standard designs templates that can be easily modified to fit specific roadways.

2. PROCESS FRAMEWORK

The Neighborhood Traffic Management Program is a partnership between the City and its residents. Participation begins with the initial petition filing, continues with the development of a neighborhood traffic calming plan, then moves to the final step of determining neighborhood support. The process framework identifies the steps by which the Development and Engineering Services (DES) staff and community members interact and participate in the NTMP. Figure 1 on the following page graphically illustrates the NTMP process framework. The accompanying text below provides greater detail.

The process framework is comprised of four key elements that focus on specific tasks and conclude with the implementation of a traffic calming plan.

- Plan Initiation – Is my street eligible for traffic calming consideration?
- Plan Development – Who develops the traffic calming plan?
- Plan Support – What are the requirements for neighborhood support?
- Plan Implementation – How are the supported traffic calming measures installed?

Each step of the Process Framework is numbered and corresponds with Figure 1.

This chapter also includes a “Process for Removal”. This process presents the framework for removal of neighborhood calming devices in the event residents wish to have certain aspects of the implemented plan removed.

PLAN INITIATION

This component describes how to initiate the NTMP and determine eligibility.

1 – Assess DES Workload and Determine Number of Areas to be Treated

Before initiating a local traffic calming plan, staff will review the number of areas that can be treated in given year based on the city’s traffic calming budget and workload. This assessment is important to balance the resources of the department due to the close oversight and required level of staff involvement.

2 – Citizen Request

The process is initiated when a resident(s) submits a request to DES staff to investigate speeding, traffic volumes, or traffic-related safety concerns within their neighborhood. Requests for City-maintained streets should provide sufficient detail for staff to understand the traffic-related concern and magnitude. The action initiates the dialogue between the resident(s) and DES staff. Requests can be submitted via letter or e-mail. Requests in writing from City Council will also initiate the process.

1. Plan Initiation

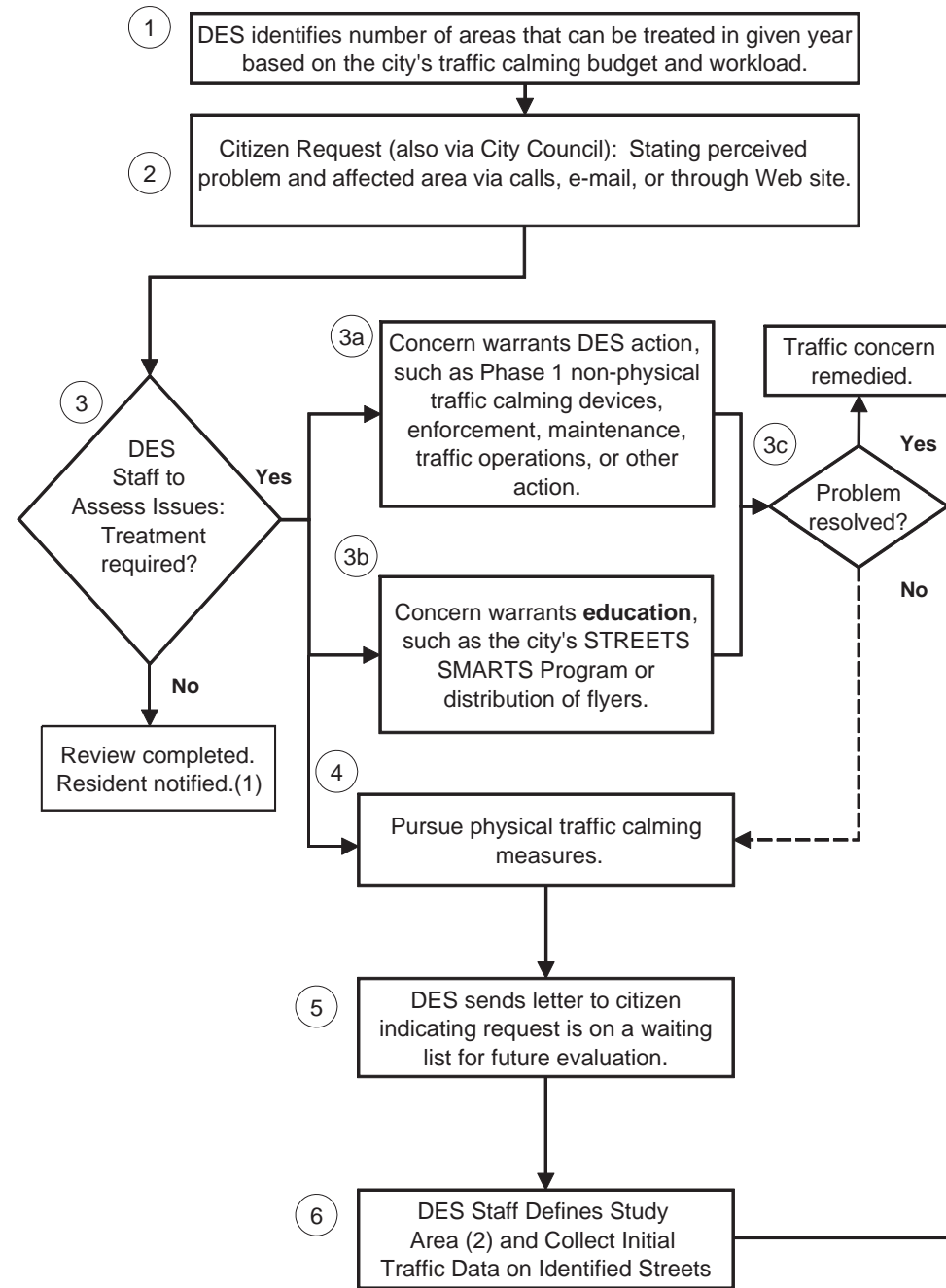

2. Plan Development

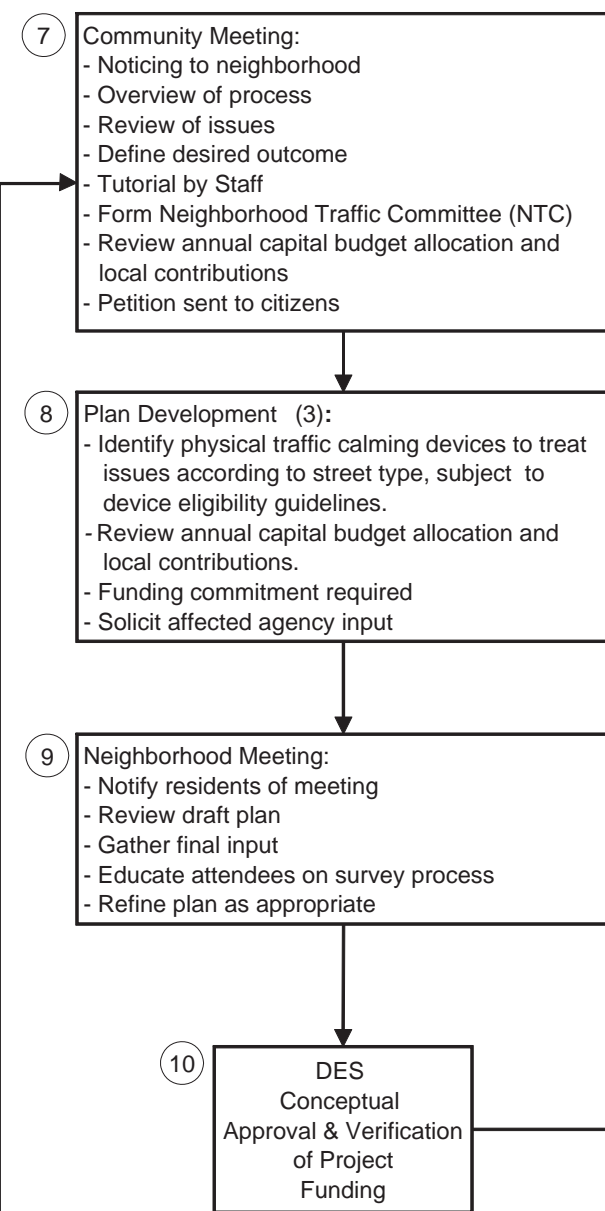

3. Plan Support

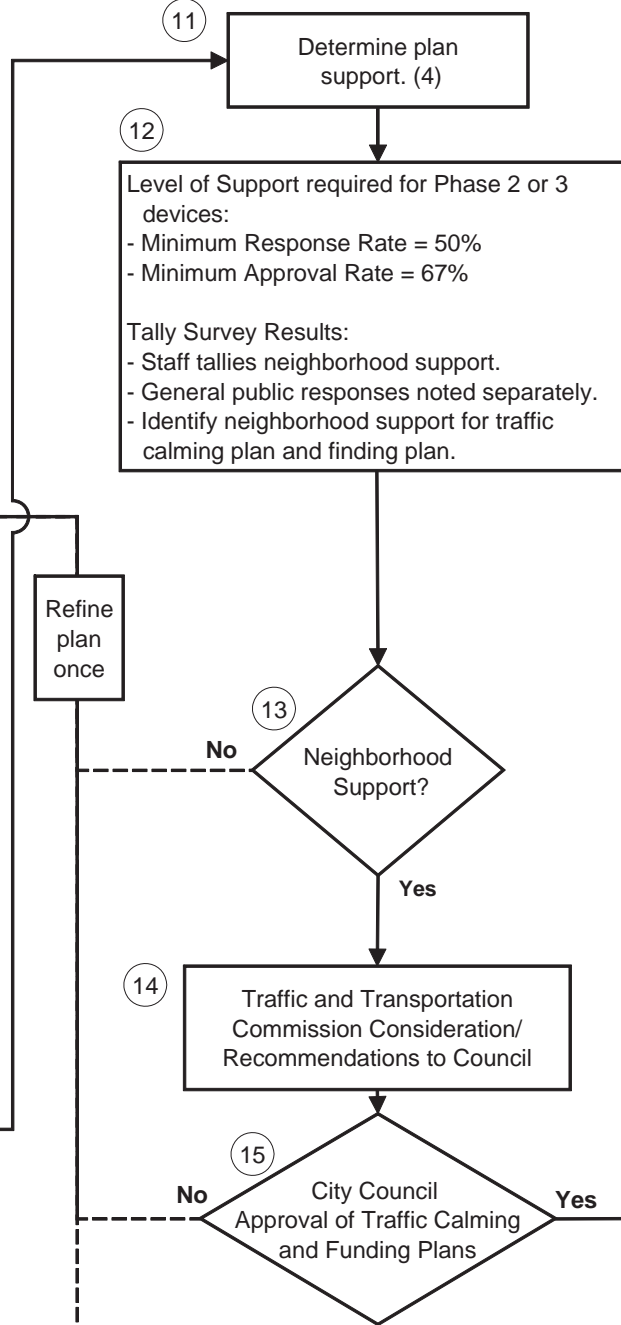

4. Plan Implementation

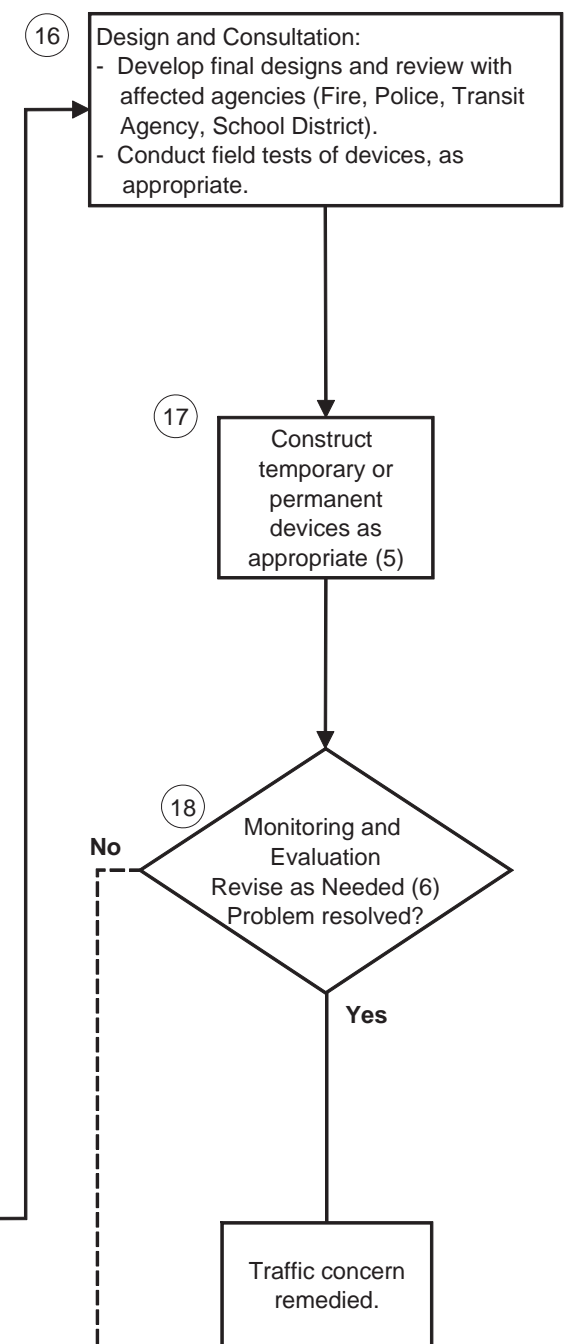

- (1) A response is sent to every citizen who made a request informing them of the course of action.
- (2) Study area to include all streets that may experience a significant change in traffic due to treatment and will generally be bounded by arterials, freeways, rivers, etc.
- (3) First round of plan development will focus on speed control devices, if Development and Engineering Services (DES) implementation of non-physical measures in Step 3a/3b.
- (4) Surveys distributed within study area. Multi Unit Dwellings' responses do not count toward the minimum response rate. Survey includes three questions: (a) Do you support the proposed plan? (b) Would you oppose a traffic calming device adjacent to your property? (c) Would you contribute to neighborhood funding of the proposed traffic calming measures?
- (5) Temporary devices are constructed at staff discretion based on previous experience. Temporary devices can be converted to permanent devices after 6 months of acceptable performance.
- (6) If non-physical and speed control devices are found to be ineffective, DES may initiate volume control plan.

3 – Assess Traffic

DES staff will review the petition and determine the appropriate course of action. Certain traffic concerns may be remedied through methods other than physical traffic calming devices **(3a)**. For instance, staff may initially install non-physical traffic calming devices (see Chapter 3) that utilize signs and roadway striping, conduct landscaping maintenance (e.g., trees blocking a stop sign), request targeted speed enforcement by the Salinas Police Department, or provide other engineering related improvements. Additionally, DES staff may distribute or assist residents with distribution of educational flyers reminding local residents of the rules of the road and safe neighborhood driving habits **(3b)**. Following these actions, staff will determine whether the treatments remedied the cited concern based on technical documentation **(3c)**.

The City will send a response letter to the individual who submitted the original request, indicating the initial action City staff intends to undertake. If the non-physical traffic calming measures or other actions do not eliminate the concern, staff may recommend physical traffic calming treatments.

4 – Traffic Calming Issue

Upon receipt of the request or determination that previous non-physical traffic calming actions did not address the cited concerns, DES staff may elect to pursue a traffic calming plan with local residents.

5 – Citizen Notified of Course of Action

Staff will send a letter to those residents indicating that their request is on a waiting list for future evaluation pending available City resources. If the number of requests exceeds staff resources, staff will select requests first on a safety priority basis (i.e., locations with a higher than expected number of collisions, higher pedestrian/bicycle concentration locations such as schools, community centers, or libraries) and second on a first-come-first-served basis. The remaining locations will be placed on a waiting list.

To provide residents with another avenue for treatment, neighborhoods can elect to fund the analysis and construction of traffic calming devices to consider expedited neighborhood treatment. The neighborhood must prove the financial ability to fund 100 percent of the anticipated costs, which include field analysis, plan development, engineering drawings, and construction. Upon proof of financial ability, the City can elect to authorize the neighborhood's request to develop a traffic calming plan.

6 – DES Defines Study Area and Collect Initial Traffic Data

Upon notification to proceed, DES staff will initially define the study area, which may be a specific street or much larger area such as a neighborhood. The size of the study area depends on the extent of the traffic-related concerns and should include any streets that could serve as an alternative route to the treated street. The study area may also include streets that have their only access to the treated street (e.g., cul-de-sac). Boundary lines can also follow geographic features such as a creek, hillside, open space, or an arterial roadway. The study area may later be refined with resident input.

**City of Salinas
Neighborhood Traffic Calming Petition Form**

Name of Person Submitting Petition form: _____

Date: _____

Phone Number: _____

Address: _____

Your street or neighborhood is being considered for participation in the City of Salinas Neighborhood Traffic Management Program (NTMP). This program addresses neighborhood speeding and traffic volume concerns through the use of traffic calming devices. Individual neighborhood plans will partially or completely be funded by the City of Salinas Development and Engineering Services (DES) Division; however, a percentage of the costs may be borne by the neighborhood.

Initial Description of Problem: _____

To verify local support, please provide the names, signatures, and contact information of at least 10 residents and/or property owners 18 years and older (from separate households) who support requesting that this neighborhood be considered for selection in the next NTMP cycle.

If the necessary signatures are attained, the City of Salinas Development and Engineering Services (DES) Division will initiate a neighborhood meeting to discuss neighborhood traffic issues and begin development of a traffic calming plan.

	Printed Name	Signature	Address	Phone No.
1.	_____	_____	_____	_____
2.	_____	_____	_____	_____
3.	_____	_____	_____	_____
4.	_____	_____	_____	_____
5.	_____	_____	_____	_____
6.	_____	_____	_____	_____
7.	_____	_____	_____	_____
8.	_____	_____	_____	_____
9.	_____	_____	_____	_____
10.	_____	_____	_____	_____

Based on the study area, DES staff will collect traffic data on streets identified as a concern. Traffic data collection will include the following:

- Street width and length
- Traffic speeds
- Traffic volumes
- Collision history

Traffic speeds and volumes should be collected for a minimum of 48 hours using a mechanical traffic counter or other appropriate device. Staff may elect to conduct a radar speed surveys to verify traffic speeds or conduct a time specific speed survey. Surveys should be collected on all potentially affected streets to insure a comprehensive set of base data for comparison purposes.

PLAN DEVELOPMENT

The plan development component is a collaborative effort between DES staff and a Neighborhood Traffic Calming Committee (NTC). They will work together to develop a traffic calming plan by completing the following steps:

7 – Neighborhood Kick-off Meeting

For those requests selected by DES staff, they will send a petition to the individual who initially requested the investigation. The petition requires a minimum of 10 signatures in support of pursuing a traffic calming plan. The signatures must be from individuals 18 years and older and from separate households. If the requesting individual cannot attain the minimum required 10 signatures, the request will be terminated. For streets or street segments with fewer than 10 residential units, the City may elect to accept the signatures from a majority of household residents.

Staff will notify study area residents, property owners, and business owners of a neighborhood meeting to learn more about the selection of their neighborhood area to participate in the NTMP. DES staff will host a neighborhood meeting to provide an overview of the NTMP and the process to develop, approve, and implement a neighborhood traffic calming plan. At this meeting, staff will accomplish the following:

- Review traffic-related issues – Discuss the type of issue(s), location(s), and time of occurrences. Collect any additional information regarding traffic-related issues.
- Refine Study area (if necessary) – Staff will refine the study area based on street(s) affected by the traffic-related issues or that may be potentially affected by development of a neighborhood traffic management plan.
- Review traffic data – Review the initial data collected and determine whether additional data collection is necessary.
- Neighborhood traffic management tutorial – Present an overview of available neighborhood traffic calming devices.
- Discuss Funding – The DES will identify the available funding sources and the anticipated amount of funding to be borne by the neighborhood for the construction of traffic calming devices. In addition, residents will be informed of the opportunity to fund enhanced aesthetic features, such as landscaping.

DES staff will provide interested residents the opportunity to volunteer and participate on the NTC. The NTC will meet with DES staff to review and develop a plan for their neighborhood. Although all residents have the opportunity to provide input and receive updates as the plan develops, the NTC is more actively involved, committing the time and effort necessary to develop a comprehensive plan.

8 – Plan Development

The NTC and DES staff will develop a short list of traffic calming devices to most appropriately treat the traffic concerns. Staff will provide guidance on the selection and placement of the devices. The Toolbox Guideline Tables 1-3 (see Chapter 4) can help to determine the most appropriate devices. The NTC will ultimately present the proposed plan to residents of the study area for public review and comment.

Following implementation on non-physical devices in the initial phase (step 3), Staff will use the following types of physical traffic calming measures to treat the traffic related concerns (see Toolbox chapter for more information):

- Vertical Devices – Speed humps, speed lumps, speed tables, etc.
- Narrowing Devices – Bulbouts, chokers, center island narrowings, etc.
- Horizontal Devices – Traffic circles, chicanes, lateral shifts, etc.

Because volume control measures (e.g., partial closures or forced turn islands) intentionally divert traffic to another street, new issues are likely to occur as a result. The City strongly promotes connectivity in and between neighborhoods to distribute traffic and minimize all modes of travel. For these reasons, volume control devices should be reserved until all other options have proven ineffective at reducing the traffic-related impacts.

Once DES staff and NTC have developed a plan that will adequately address the neighborhood concerns and finalized the committed funding sources, staff will solicit feedback from local service providers that may be affected by the plan. The intent is to identify concerns and develop viable alternatives to strike a balance between goals of the NTMP and the needs of other agencies. The following service providers should be included as appropriate when coordinating the plan review.

- City of Salinas Fire District
- City of Salinas Police Department
- Ambulance Service Providers
- Monterey Salinas Transit
- Local School District / Bus Service
- Solid waste collection companies

9 – Proposed Plan Neighborhood Meeting

DES staff will notify the study area residents of a neighborhood meeting to review the Proposed Plan. Residents will have the opportunity to review and provide input on the proposed plan. At this meeting, the NTC will present a map of the proposed plan, describe the types and locations of devices proposed, and discuss the estimated construction costs. If applicable, the NTC will also discuss the aesthetic improvements to gauge resident support. Changes to the proposed plan can be made as necessary.

The DES will also inform residents of the approval process and ballots they will receive once the proposed plan is refined.

10 – DES Conceptual Approval and Verification of Project Funding

Prior to determining neighborhood support, DES staff will conceptually approve the plan and verify placement of all proposed traffic calming devices. Staff will also verify the residents' financial responsibility for the proposed plan. The residents' financial responsibility may include a portion of the construction costs and any costs for aesthetic upgrades.

NEIGHBORHOOD SUPPORT

The neighborhood support component assesses the amount of local neighborhood support for the proposed plan in the form of mail-in ballots. DES staff will mail the ballots to the study area residents, property owners, and applicable business owners.

11 – Determine Plan Support

Before distributing ballots, staff will inform residents in the study area regarding the pending vote with an informational brochure. The combination of this step and the neighborhood meeting (Step 9) will help to ensure that residents of the study area are properly informed.

Ballots will be distributed to study area residents, property owners, apartment units, and businesses owners (if applicable). The ballots will include a description and map of the proposed plan indicating the type and location of devices being proposed. The ballot will also include a mail-back postcard with three questions for residents to respond to:

- Do you support the proposed plan?
- Would you oppose traffic calming devices along your property frontage?
- Would you contribute to neighborhood funding for the construction of the proposed traffic calming measures?

The mail-back postcard will also provide a space for residents to write comments regarding the proposed plan.

In addition to determining the local neighborhood support, staff will provide the opportunity for residents living outside of the immediate study area to voice their opinions, such as posting a neighborhood sign with city contact information or accepting comments through e-mail or a Web site. The magnitude of support by the general public will also be considered in the plan approval, but safety issues should govern the final decision for implementation.

12 – Minimum Neighborhood Support

A minimum response rate and approval rate must be obtained before staff can construct the proposed plan. At least 50 percent of all ballots must be returned with at least 67 percent of returned ballots in favor. For example, if 100 ballots are mailed out, at least 50 must be returned with 34 in favor of the proposed plan.

Apartments present a unique situation because residents may be less likely to respond. For this reason, ballots from apartment units are not counted toward the minimum response rate, but will be counted in favor or against the proposed plan.

DES staff will count all received ballots and determine whether the minimum response rate and approval rate are satisfied. Staff will also tally the general public input.

13 – Neighborhood Support

If the minimum response rate and approval rate is satisfied, the DES will approve the proposed plan and submit the project for funding consideration.

If staff does not receive the minimum number of ballots, staff can assist the NTC in reminding neighborhood residents to submit their mail-back postcards in order to meet the minimum response rate. NTC members are encouraged to solicit input from their neighbors.

If the minimum response rate is met but the approval rate is not satisfied, the NTC has one opportunity to revise the plan. The DES staff and NTC will identify the aspects of the plan not favored by the neighborhood residents. Modifying the plan may also require soliciting a second review by the local service providers, holding a public meeting to present the revised plan, and redistributing ballots to the affected area. Before supplemental work, the DES will need to assess the department's workload and financial needs to revise the plan.

If the minimum response rate and approval rate are satisfied, then the plan continues to the final component of the process.

14 – TTC Consideration/Recommendation to City Council

DES staff will present to the Traffic and Transportation Commission (TTC) a map of the community approved plan, describe the types and locations of devices proposed, and summarize the estimated construction costs. If applicable, DES staff will also discuss the aesthetic improvements provided by selected measures. The TTC will make its recommendation to the City Council based on this presentation.

15 – City Council Approval of Traffic Calming and Funding Plans

Similar to the TTC public meeting, DES staff will present a map of the community approved plan, describe the types and locations of devices proposed, summarize the estimated construction costs, and discuss the recommendation from the TTC. The City Council will either approve the traffic calming and funding plans to initiate construction, or recommend additional improvements and modifications to the plan – requiring a return to step 8.

PLAN IMPLEMENTATION

The final component consists of preparing the design plans, constructing, and monitoring the approved traffic calming devices.

16 – Design and Consultation

Upon approval of the proposed plan, DES staff will prepare the necessary design plans for each traffic calming device and consult with local service providers if necessary. The DES may conduct field tests to verify that local service providers' vehicles can navigate through or around the proposed designs. DES will make modifications to the approved devices as necessary.

17 – Construction

Before constructing the traffic calming devices, the DES will inform the public and local service providers of the pending traffic calming devices. The DES will also provide education materials to inform local residents how to negotiate unfamiliar devices, as necessary.

The DES or a City contractor will construct the approved traffic calming devices. The staff may decide to construct temporary devices based on previous experience. DES staff will incorporate aesthetics into the design and construction of temporary devices where possible, but these devices may not be visually appealing due to cost limitations. Aesthetics will be a higher priority for permanent devices.

18 – Monitoring and Evaluation

The DES will monitor the effectiveness and neighborhood perception of the constructed devices for three to six months. Following the monitoring period, the DES will collect traffic speed and volume data for the treated streets and quantitatively determine the effects of the plan.

After constructing the approved plan, the DES will rely on the NTC and community members for feedback on the constructed devices. Based on the NTC and/or community members' feedback, the DES will determine the next steps. For example, the approved plan may have produced reasonable and satisfactory results, and, therefore, no further action is required.

If the approved plan has not produced reasonable and satisfactory results, the DES can recommend one of the following:

- Collect additional traffic data as deemed appropriate
- Modify constructed devices as deemed appropriate
- Construct additional speed control devices as deemed appropriate

If the DES determines that additional speed control devices will not adequately address the traffic-related concern, the DES can recommend the use of alternative measures or programs.

Before supplemental work begins, the DES will assess the department's workload and financial needs to revise the plan.

PROCESS FOR REMOVAL

The DES recognizes that after devices are approved and implemented, residents may wish to remove these devices. Historically, once installed, most traffic calming devices remain due to local support. This section provides guidelines for a systematic removal process.

Similar to the process for implementing neighborhood traffic calming devices, the removal process is resident-driven. The process requires that the same affected area be involved in the decision process for the removal of devices. As detailed below, greater neighborhood support is also required to verify that the neighborhood truly wants the devices removed. *Residents must bear the costs for removal.*

The removal process is described below, and the flowchart in Figure 2 outlines the removal process. Each step below is numbered and corresponds to the flowchart on Figure 2.

1 – Citizen Petition for Removal of Device(s)

To initiate the removal process, a resident living in the neighborhood where the device removal is being considered must submit a petition. The petition cannot be submitted within the first year of operation. The petition must be submitted with a minimum of 10 signatures from separate households. The petition must also state the location(s) of device(s) and reason for removal.

Once DES staff receives the petition, they will organize and distribute ballots for the removal process.

2 – Distribute Ballots

Ballots will be distributed to those residents, property owners, and business owners from the original study area. Although tenants or property owners may have changed, the same addresses will be provided the opportunity to participate in the approval process. The ballots will contain descriptions and maps of devices and locations proposed for removal. The ballot will also include a mail-back postcard that residents can use to indicate their support for or against the proposed removal. The ballot will also provide a space for residents to write comments regarding the removal.

3 – Required Neighborhood Support

A higher minimum response rate and approval rate must be met by those households on the treated street. A minimum of 75 percent of all ballots must be returned with at least 75 percent of all ballots received in favor of removal.

Similar to the installation process, apartment units do not count toward the minimum response rate. If the minimum response or approval rates are not met, residents must wait three years before refileing the petition **(3a)**.

4 – Approval by DES

If the neighborhood support meets the minimum response and approval rates, the DES will calculate the estimated removal cost. The neighborhood must prove the ability to fund 100 percent of the anticipated costs. Upon proof of financial ability, the DES can elect to authorize the removal of the specified devices **(4a)**. A letter will be sent to all local service providers (e.g., Fire Department) indicating the location of device(s) to be removed **(4b)**. If the full cost or removal is not provided, residents must wait three years before refileing the petition **(4c)**.

Figure 2 NTMP Process For Removal

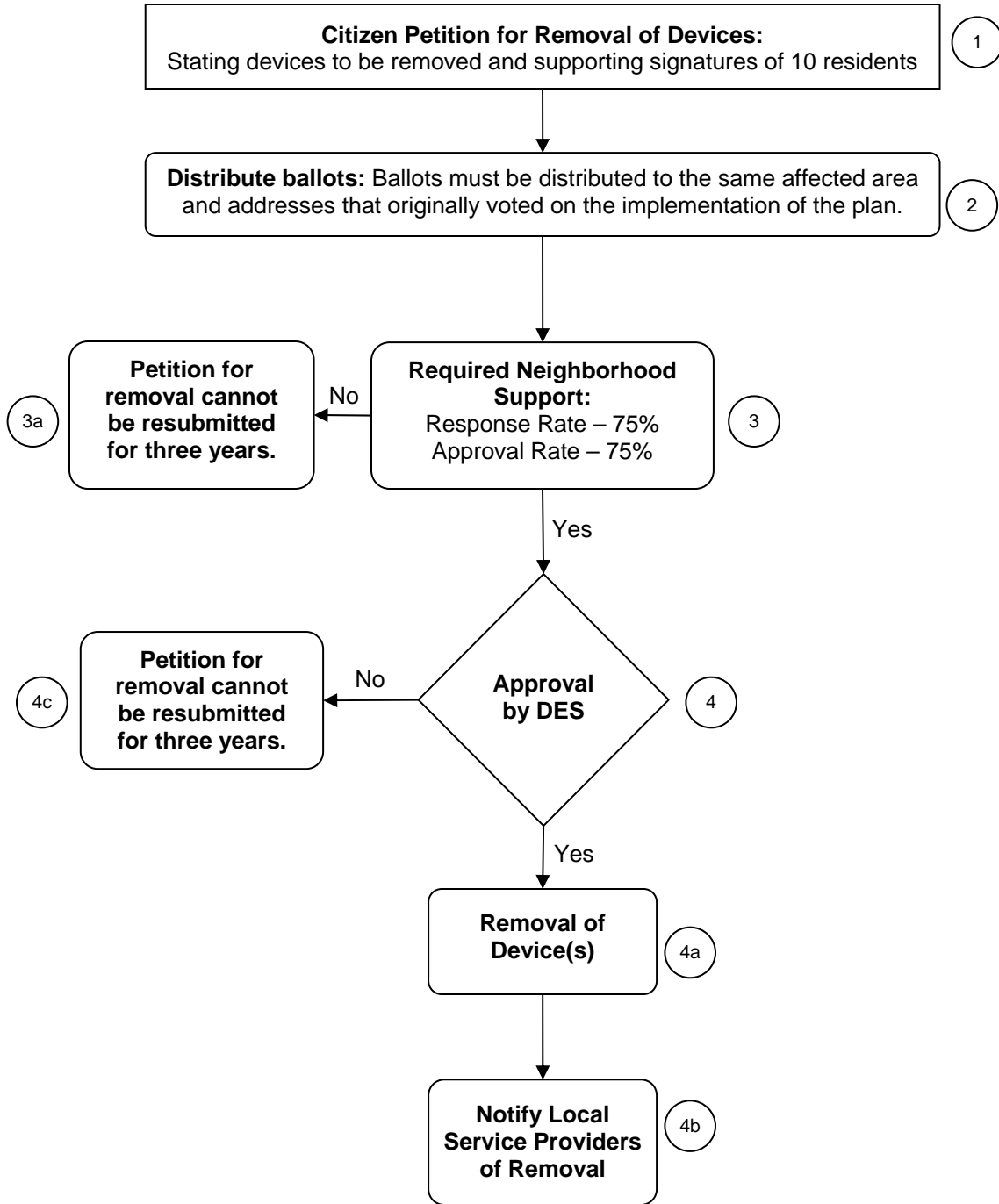

3. TOOLBOX

This chapter of the NTMP summarizes the “toolbox” of devices that are available to the City of Salinas and community members when developing neighborhood traffic calming plans. The “toolbox” contains 31 different devices that address neighborhood traffic related concerns such as speeding vehicles, high traffic volumes, cut-through traffic, or collisions at neighborhood intersections. The devices vary in their ability to treat various traffic related concerns. For this reason, Chapter 4, “Toolbox Guidelines,” provides guidance on selecting the most appropriate devices given the type of specific traffic-related concern and street being treated.

The “toolbox” of neighborhood traffic management devices can be grouped into three categories:

- Non-Physical devices
- Speed Control
 - Narrowing devices
 - Horizontal devices
 - Vertical devices
- Volume Control devices

For each device in the “toolbox,” the following information relating to each device is provided:

- Description of the measure
- Photograph and/or schematic
- List of advantages and disadvantages
- Data sheet indicating speed, volume, or collision reduction potential
- Estimated costs

Cost approximations are based on 2006 costs and are provided for information purposes only. Actual costs depend on many factors, including dimensions of device, construction materials, and actual construction costs.

NON-PHYSICAL DEVICES

Description

Non-physical devices include any measures that do not require physical changes to the pavement section or curbs. Non-physical devices are intended to increase drivers' awareness of surroundings and influence driver behavior without physical obstructions. DES staff will initially implement non-physical devices to treat traffic related concerns. However, these devices are not self enforcing and may have limited effectiveness as stand-alone devices. This category includes the following devices:

- Targeted Speed Enforcement
- Speed Radar Trailers
- Speed Feedback Sign
- Centerline/Edgeline Lane Striping
- Optical Speed Bars
- Signage
- Speed Legend
- Centerline/Edgeline Reflectors
- High Visibility Crosswalks
- Angled Parking

Targeted Speed Enforcement

City Staff or NTC members can identify locations for temporary targeted enforcement, based on personal observations and survey comments. A request can be submitted to the Salinas Police Department (SPD) for the desired enforcement. Because of limited SPD resources, the duration of the targeted enforcement may be limited.



Targeted enforcement may also be used in conjunction with new neighborhood traffic management devices to help drivers become aware of the new restrictions.

Advantages

- Inexpensive if used temporarily
- Does not physically slow emergency vehicles or buses
- Quick implementation

Disadvantages

- Expensive to maintain an increased level of enforcement
- Effectiveness may be temporary

Approximate Cost: No additional cost.

Speed Radar Trailers

A radar trailer is a device that measures each approaching vehicle's speed and displays it next to the legal speed limit in clear view of the driver. They can be easily placed on a street for a limited amount of time then relocated to another street, allowing a single device to be effective in many locations.



Advantages

- Portable
- Does not physically slow emergency vehicles or buses
- Quick implementation

Disadvantages

- Effectiveness may be temporary
- Drivers may divert to alternate streets due to uncertainty of device implications
- Subject to vandalism

Approximate Cost: No direct cost. (Purchase \$6,000 - \$12,000)

Speed Feedback Signs

Speed feedback signs perform the same functions as radar trailers but are permanent. Real-time speeds are relayed to drivers and flash when speeds exceed the limit. Speed feedback signs are typically mounted on or near speed limit signs.



Approximate Cost: \$7,500 - \$10,000

Centerline/Edgeline Lane Striping

Lane striping can be used to create formal travel lanes, bicycle lanes, parking lanes, or edge lines. As a neighborhood traffic management measure, they are used to narrow the travel lanes for vehicles, thereby inducing drivers to lower their speeds. The past evidence on speed reductions is, however, inconclusive.



Approximate Cost: \$2.00 per linear foot

Advantages

- Real-time speed feedback
- Does not physically slow emergency vehicles or buses
- Permanent installation

Disadvantages

- May require power source
- Only effective for one direction of travel
- Long-term effectiveness uncertain
- Subject to vandalism

Advantages

- Inexpensive
- Can be used to create bicycle lanes or delineate on-street parking
- Does not slow emergency vehicles

Disadvantages

- Has not been shown to significantly reduce travel speeds
- Requires regular maintenance

Optical Speed Bars

Optical speed bars are a series of pavement markings spaced at decreasing distances. They have typically been used in construction areas to provide drivers with the impression of increased speed. They do not provide long-term speed reduction benefits.

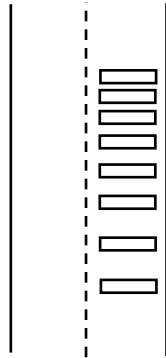

Advantages

- Inexpensive
- Does not physically slow emergency vehicles or buses

Disadvantages

- Long-term effects in residential area unknown
- Increases regular maintenance

Approximate Cost: \$1.00 per linear foot

Signage

Various signs may also be useful in alerting driver of certain conditions. Examples include:

- "Cross Traffic Does Not Stop" Signs
- Truck Restriction Signs



Advantages

- Inexpensive
- Truck restrictions can reduce through truck traffic
- Does not slow emergency vehicles or buses

Disadvantages

- Requires regular maintenance
- Speed limit signs are not applicable because they do not necessarily change driver behavior
- If speed limits are set unreasonably low, drivers are more likely to exceed it

Approximate Cost: \$150 - \$500 per sign

Speed Legend

Speed legends are numerals painted on the roadway indicating the current speed limit in miles per hour. They are usually placed near speed limit signposts. Speed legends can be useful in reinforcing a reduction in speed limit between one segment of a roadway and another segment. They may also be placed at major entry points into a residential area.



Approximate Cost: \$75 per location

Centerline/Edgeline Reflectors

Reflectors (also known as Botts dots or “raised pavement markers”) are small bumps lining the centerline or edgeline of a roadway. They are often used on curves where vehicles have a tendency to deviate outside of the proper lane, risking collision. Raised reflectors improve the nighttime visibility of the roadway edges and provide a low impact physical reminder to drivers if driven over.



Approximate Cost: \$4.50 per marker

Advantages

- Inexpensive
- Helps reinforce a change in speed limit
- Does not slow emergency vehicles

Disadvantages

- Has not been shown to significantly reduce travel speeds
- Requires regular maintenance

Advantages

- Inexpensive
- Does not physically slow emergency vehicles or buses
- Can help keep drivers in the appropriate travel lane on curves and under low-visibility conditions

Disadvantages

- Noise caused by tire impact
- Requires regular maintenance
- Has not been shown to significantly reduce travel speeds

High Visibility Crosswalks

High-visibility crosswalks use special marking patterns and raised reflectors to increase the visibility of a crosswalk. A “triple-four” marking pattern is created by painting two rows of four-foot wide rectangles, separated by four feet of unpainted space across the roadway. Raised reflectors are placed at the approach edges of these rectangles. The unpainted space along the center of the crosswalk provides an untreated path for wheelchair users and foot traffic, as markings may become slippery in rainy/wet conditions. See Appendix C for the City of Salinas



Pedestrian Safety Enhancement Devices Policy, which describes the City accepted standards of high visibility crosswalks in school zones.

Advantages

- Increased visibility of crosswalk
- Focus crossing pedestrians at a single location

Disadvantages

- May give pedestrians a false sense of security, causing them to pay less attention to traffic
- Requires more maintenance than normal crosswalks

Approximate Cost: \$1,600 per location

Angled Parking

Angled parking reorients on-street parking spaces to a 45-degree angle, increasing the number of parking spaces and reducing the width of the roadway available for travel lanes. Angled parking is also easier for vehicles to maneuver into and out of than parallel parking.



Consequently, it works well in areas with high parking demand and turnover rates, and where street widths are wider than normal 50 foot or greater cross-sections.

Advantages

- Reduces speeds by narrowing the travel lanes
- Increases the number of parking spaces
- Provides for easier parking maneuvers that take less time than parallel parking
- Favored by businesses and multi-family residences

Disadvantages

- Precludes the use of bike lanes (unless roadway is wider than 58 feet)
- Ineffective on streets with frequent driveways
- Potential for collisions when backing out

Approximate Cost: Dependent on amount of parking

SPEED CONTROL – NARROWING DEVICES

Description

Narrowing devices use raised islands and curb extensions to physically narrow the travel lane for motorists. The narrowing devices in the toolbox include:

- Neckdown/Bulbout
- Center Island Narrowing/Pedestrian Refuge
- Two-Lane Choker
- One-Lane Choker

Each narrowing device is illustrated and described on the following pages.

Neckdown/Bulbout

Neckdowns/bulbouts are raised curb extensions that narrow the travel lane at intersections or midblock locations. Neckdowns/bulbouts “pedestrianize” intersections by shortening the crossing distance and decreasing the curb radii, thus reducing turning vehicle speeds. Both of these effects increase pedestrian comfort and safety at the intersection.

The magnitude of speed reduction is dependent on the spacing of neckdowns between points that require drivers to slow (see page 56). On average, neckdowns achieve a 7 percent reduction in speeds.

Approximate Cost: \$6,000 – \$12,000 per corner

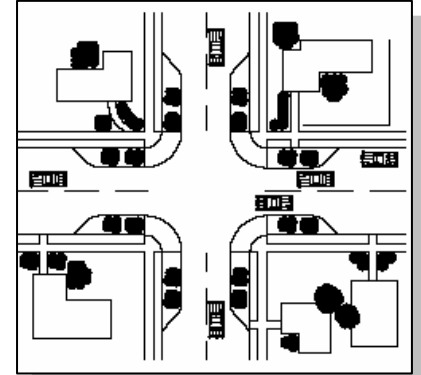

Measured Effectiveness		
Speed Reduction	Reduction in 85th Percentile Speeds between Slow Points	-7%
Volume Reduction	Reduction in Vehicles per Day	-10%
Safety Reduction	Reduction in Average Annual Number of Collisions	I/D
Note: I/D = Insufficient Data to predict reduction effect.		
Source: Traffic Calming: State of the Practice, 2000.		

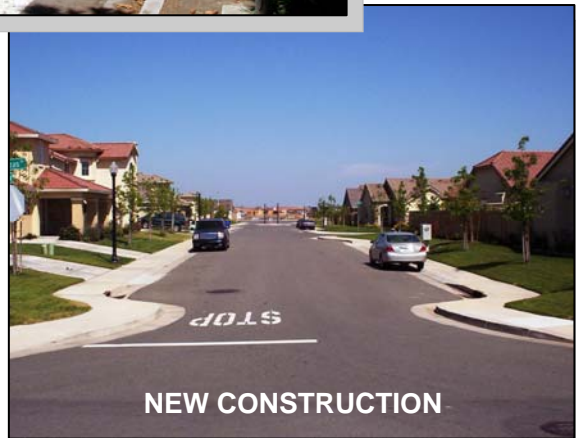

Advantages

- Reduces pedestrian crossing distance and exposure to vehicles
- Through and left-turn movements are easily negotiable by large vehicles
- Creates protected on-street parking bays
- Reduces speeds (especially right-turning vehicles) and traffic volumes

Disadvantages

- Effectiveness is limited by the absence of vertical or horizontal deflection
- May slow right-turning emergency vehicles
- Potential loss of on-street parking
- May require bicyclists to briefly merge with vehicular traffic

Center Island Narrowing/Pedestrian Refuge

Center island narrowings are raised islands located along the centerline of a street that narrow the travel lanes at that location. Placed at the entrance to a neighborhood, and often combined with textured pavement, they are often called "gateways." Fitted with a gap to allow pedestrians to walk through at a crosswalk, they are often called "pedestrian refuges." They can also be landscaped to increase visual aesthetics.

The magnitude of speed reduction is dependent on the spacing of center island narrowings between points that require drivers to slow (see page 56). On average, center island narrowings achieve a 7 percent reduction in speed.

Approximate Cost: \$10,000 - \$15,000 per location

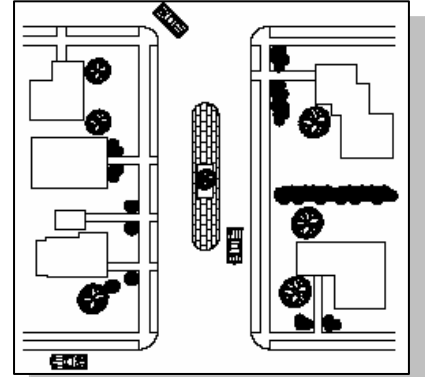

Measured Effectiveness		
Speed Reduction	Reduction in 85th Percentile Speeds between Slow Points	-7%
Volume Reduction	Reduction in Vehicles per Day	-10%
Safety Reduction	Reduction in Average Annual Number of Collisions	I/D
Note: I/D = Insufficient Data to predict reduction effect. Source: Traffic Calming: State of the Practice, 2000.		

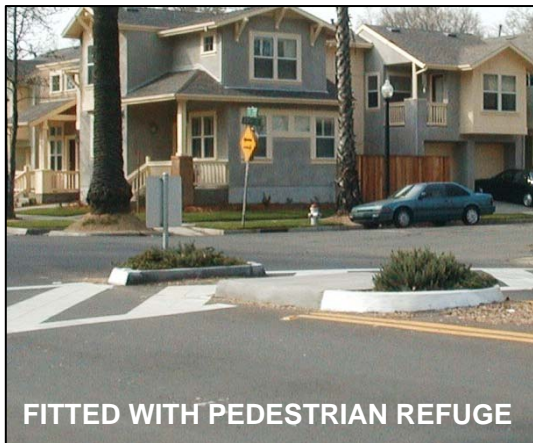

Advantages

- Can increase pedestrian safety
- Aesthetic upgrades can have positive aesthetic value
- Reduces traffic volumes if alternative routes are available

Disadvantages

- Effect on vehicle speeds is limited by the absence of any vertical or horizontal deflection
- Potential loss of on-street parking

Two-Lane Choker

Chokers are curb extensions at midblock that narrow a street. Chokers leave the street cross section with two lanes that are narrower than the normal cross section.

The magnitude of speed reduction is dependent on the spacing of two-lane chokers between points that require drivers to slow (see page 56). On average two-lane chokers achieve a 7 percent reduction in speed.

Approximate Cost: \$7,000 - \$8,000 per location

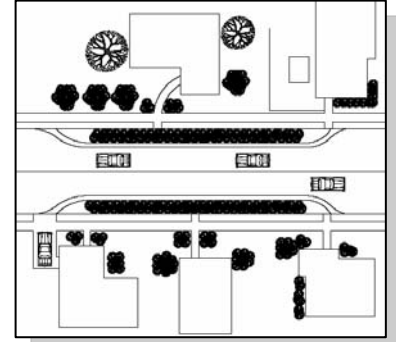

Measured Effectiveness		
Speed Reduction	Reduction in 85th Percentile Speeds between Slow Points	-7%
Volume Reduction	Reduction in Vehicles per Day	-10%
Safety Reduction	Reduction in Average Annual Number of Collisions	I/D
Note: I/D = Insufficient Data to predict reduction effect.		
Source: Traffic Calming: State of the Practice, 2000.		



Advantages

- Easily negotiable by emergency vehicles and buses
- Can have positive aesthetic value
- Reduces both speeds and volumes

Disadvantages

- Effect on vehicle speeds is limited by the absence of any vertical or horizontal deflection
- May require bicyclists to briefly merge with vehicular traffic
- Loss of on-street parking
- Build-up of debris in gutter

One-Lane Choker

One-lane chokers narrow the roadway width such that there is only enough width to allow travel in one direction at a time. They operate similarly to one-lane bridges, where cars approaching on one side must wait until all traffic in the other direction has cleared before proceeding.

The magnitude of speed reduction is dependent on the spacing of one-lane chokers between points that require drivers to slow (see page 56). On average, one-lane chokers achieve a 14 percent reduction in speed.

Approximate Cost: \$8,000 - \$9,000 per location

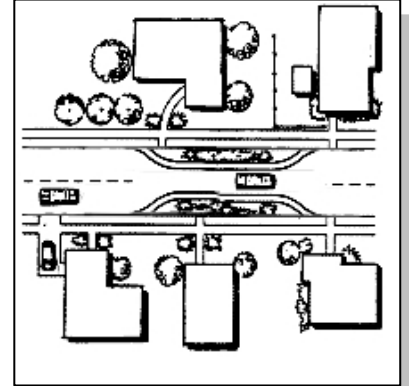

Measured Effectiveness		
Speed Reduction	Reduction in 85th Percentile Speeds between Slow Points	-14%
Volume Reduction	Reduction in Vehicles per Day	-20%
Safety Reduction	Reduction in Average Annual Number of Collisions	I/D
Note: I/D = Insufficient Data to predict reduction effect.		
Source: Traffic Calming: State of the Practice, 2000.		



Advantages

- Maintains two-way vehicle access, except at choker
- Very effective in reducing speeds and traffic volumes

Disadvantages

- Perceived as unsafe because opposing traffic is vying for space in a single lane
- Can be used only on low-volume, low speed roads
- Loss of on-street parking

SPEED CONTROL – HORIZONTAL DEVICES

Description

Horizontal deflection devices use raised islands and curb extensions to physically eliminate straight-line paths along roadways and through intersections. The horizontal deflection devices in the toolbox include:

- Traffic Circle
- Roundabout (Single-Lane)
- Chicane
- Lateral Shift
- Realigned Intersection

Traffic Circle

Traffic circles are raised islands, placed in intersections, around which traffic circulates. Stop signs or yield signs can be used as traffic controls at the approaches of the traffic circle. Circles prevent drivers from speeding through intersections by impeding the straight-through movement and forcing drivers to slow down to yield. Depending upon the size of the intersection and circle, trucks may be permitted to turn left in front of the circle.

The magnitude of speed reduction is dependent on the spacing of traffic circles between points that require drivers to slow (see page 56). On average, traffic circles achieve an 11 percent reduction in speeds and a dramatic 71 percent decrease in collisions.

Approximate Cost: \$10,000 - \$25,000 per location

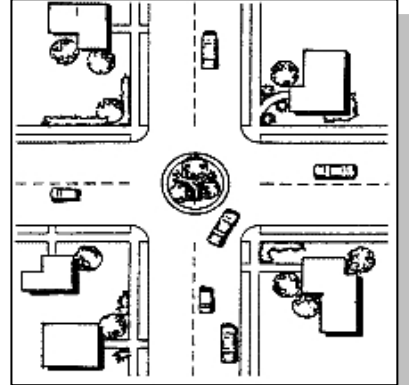

Measured Effectiveness		
Speed Impacts	Reduction in 85th Percentile Speeds between Slow Points	-11%
Volume Impacts	Reduction in Vehicles per Day	-5%
Safety Impacts	Reduction in Average Annual Number of Collisions	-71%
Source: Traffic Calming: State of the Practice, 2000.		



Advantages

- Very effective in moderating speeds and improving safety
- Can have positive aesthetic value

Disadvantages

- If not designed properly, difficult for emergency vehicles or large trucks to travel around
- Must be designed so that the circulating traffic does not encroach on crosswalks
- Potential loss of on-street parking

Roundabout (Single-Lane)

Like traffic circles, roundabouts require traffic to circulate counterclockwise around a center island. But unlike circles, roundabouts are used on higher volume streets to allocate right-of-way among competing movements. They are found primarily on collector streets, often substituting for traffic signals. They are larger than neighborhood traffic circles, have raised splitter islands to channel approaching traffic to the right, and do not have stop signs. Due to large amount of required right-of-way and construction costs, roundabouts may be most appropriate for new developments.

Roundabouts have an insignificant effect in reducing traffic speeds, but serve to allocate right-of-way at an intersection similar to a traffic signal. On average, roundabouts can reduce the average number of accidents up to 33 percent when compared to a signalized intersection.

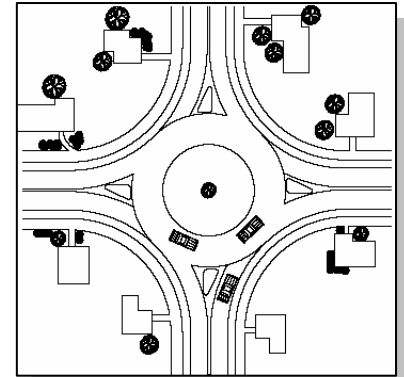

Approximate Cost: Varies by intersection and whether new construction or a retrofit.

Measured Effectiveness		
Speed Impacts	Reduction in 85th Percentile Speeds between Slow Points	I/D
Volume Impacts	Reduction in Vehicles per Day	I/D
Safety Impacts	Reduction in Average Annual Number of Collisions	-15% to -33%
Note: I/D = Insufficient Data to predict reduction effect. Source: Roundabouts: An Informational Guide, 2000.		



Advantages

- Enhanced vehicle safety compared to a traffic signal or stop sign
- Minimizes queuing at approaches to the intersection
- Less expensive to operate than traffic signals
- Can have positive aesthetic value
- Shorter pedestrian crossing distance

Disadvantages

- May require major reconstruction of an existing intersection
- Loss of on-street parking
- Continuous flow of traffic limits opportunity for pedestrians to cross (compared to signal)

Chicane

Chicanes are curb extensions that alternate from one side of the street to the other, forming S-shaped curves. Chicanes can also be created by alternating on-street parking between one side of the road and the other. Each parking bay can be created either by restriping the roadway or by installing raised center islands at each end, creating a protected parking area. Chicanes have limited effectiveness in reducing traffic speeds and volumes as compared to other devices. Little data has been collected to predict the reduction in speed, traffic volumes, or collisions, and use of this device may not result in significant decreases. Resources permitting, DES staff can collect before and after data to determine the effectiveness of chicanes.

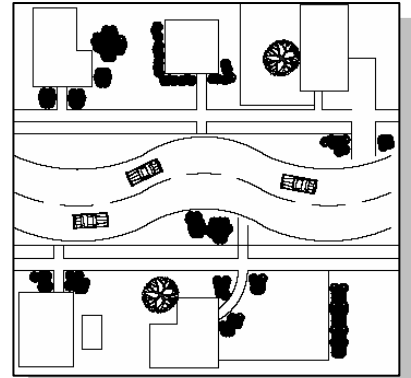

Approximate Cost: \$8,000 - \$14,000 per location

Measured Effectiveness		
Speed Impacts	Reduction in 85th Percentile Speeds between Slow Points	I/D
Volume Impacts	Reduction in Vehicles per Day	I/D
Safety Impacts	Reduction in Average Annual Number of Collisions	I/D
Note: I/D = Insufficient data to predict reduction effect.		



Advantages

- Discourages high speeds by forcing horizontal deflection
- Easily negotiable by emergency vehicles and buses

Disadvantages

- Must be designed carefully to discourage drivers from deviating out of the appropriate lane
- Curb realignment and landscaping can be costly, especially if there are drainage issues
- Loss of on-street parking

Lateral Shift

Lateral shifts are curb extensions on otherwise straight streets that cause a shift in the travel. Lateral shifts, with just the right degree of deflection, can be effective. However, lateral shifts have had limited use in the United States, and, consequently, insufficient data prevents accurate prediction of speed reduction and traffic volumes.

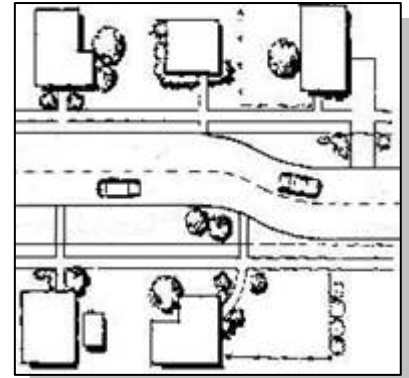

Approximate Cost: Dependent on size of offset and length of transition

Measured Effectiveness		
Speed Reduction	Reduction in 85th Percentile Speeds between Slow Points	I/D
Volume Reduction	Reduction in Vehicles per Day	I/D
Safety Reduction	Reduction in Average Annual Number of Collisions	I/D
Note: I/D = Insufficient Data to predict reduction effect.		



Advantages

- Can accommodate higher traffic volumes than many other neighborhood traffic management measures
- Easily negotiable by large emergency vehicles and buses

Disadvantages

- Potential for loss of on-street parking
- Must be designed carefully to discourage drivers from deviating out of the appropriate lane

Realigned Intersection

Realigned intersections provide deflection on an otherwise straight approach of a T-intersection. By providing deflection in the form of a curb extension or realignment, drivers are required to slow through the intersection or come to a stop before turning. Little data has been collected to predict the reduction in speed, traffic volumes, or collisions, and use of this device may not result in significant decreases. Resources permitting, DES staff can collect before and after data to determine the effectiveness of realigned intersections.

Approximate Cost: \$15,000 - \$30,000 per location

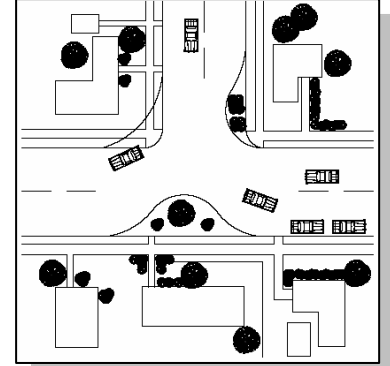

Measured Effectiveness		
Speed Reduction	Reduction in 85th Percentile Speeds between Slow Points	I/D
Volume Reduction	Reduction in Vehicles per Day	I/D
Safety Reduction	Reduction in Average Annual Number of Collisions	I/D
Note: I/D = Insufficient Data to predict reduction effect.		



Advantages

- Can be effective at reducing speeds at T-intersections
- Can be effective in increasing safety at T-intersections

Disadvantages

- Modifying curbs or drainage can be costly
- Acquiring additional right-of-way can be costly

SPEED CONTROL – VERTICAL DEVICES

Description

Vertical deflection devices use variations in pavement height and alternative paving materials to physically reduce travel speeds. The design speeds for these devices are approximately 15 to 20 mph depending on the device. The vertical deflection devices in the toolbox include:

- Speed Hump
- Speed Lump
- Speed Cushion
- Speed Table
- Raised Crosswalk
- Raised Intersection
- Textured/Colored Pavement
- Rumble Strip

Speed Hump

Speed humps are rounded raised areas placed across the road. They are generally 12 feet long (in the direction of travel), 3 to 3 ½ inches high, parabolic in shape, and have a design speed of 15 to 20 mph. They are usually constructed with a taper on each side to allow unimpeded drainage between the hump and curb. When placed on a street with rolled curbs or no curbs, bollards are placed at the ends of the speed hump to discourage vehicles from veering outside of the travel lane to avoid the device.

The magnitude of reduction in speed is dependent on the spacing of speed humps between points that require drivers to slow (see page 56). On average, speed humps achieve a 22 percent reduction in speeds.

Approximate Cost: \$2,000 - \$3,000 per location

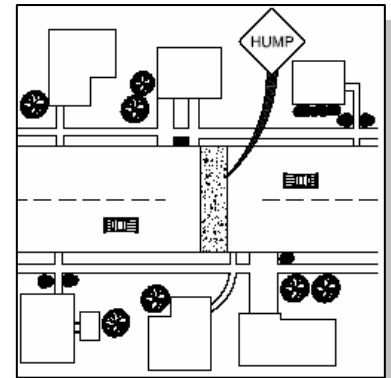

Measured Effectiveness		
Speed Impacts	Reduction in 85th Percentile Speeds between Slow Points	-22%
Volume Impacts	Reduction in Average Daily Traffic	-18%
Safety Impacts	Reduction in Average Annual Number of Collisions	-13%
Source: Traffic Calming: State of the Practice, 2000.		



Advantages

- Relatively inexpensive
- Relatively easy for bicyclists to cross
- Very effective in slowing travel speeds

Disadvantages

- Causes a “rough ride” for drivers, and can discomfort people with certain skeletal disabilities
- Slows emergency vehicles and buses
- Aesthetics
- Signs may be unwelcome by adjacent residents
- Increased noise for nearby residents

Speed Lump

The speed lump is a variation on the speed hump, adding two wheel cut-outs designed to allow large vehicles, such as emergency vehicles and buses, to pass with minimal impedance. The design limits passenger cars and most SUVs from fully passing through the cut-outs, but allows one set of wheels to pass through the cut-out while the other set is required to travel over the lump.

The magnitude of speed reduction is dependent on the spacing of speed lumps between points that require drivers to slow (see page 56). Speed lumps have a similar reduction in speeds when compared to speed humps.

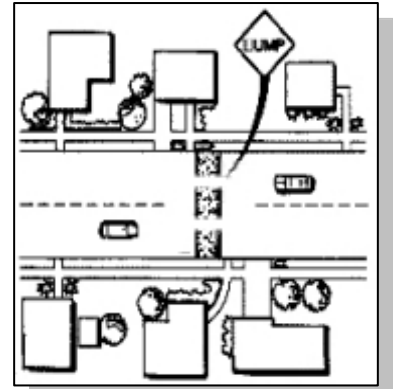

Approximate Cost: \$2,000 - \$3,000 per location

Measured Effectiveness		
Speed Reduction	Reduction in 85th Percentile Speeds between Slow Points	I/D, but comparable to speed humps
Volume Reduction	Reduction in Average Daily Traffic	
Safety Reduction	Reduction in Average Annual Number of Collisions	
Note: I/D = Insufficient Data to predict reduction effect.		



Advantages

- Effective in reducing speeds
- Maintains rapid emergency response times
- Relatively easy for bicyclists to cross

Disadvantages

- Passenger vehicles with wide wheel base can pass through the lump using the wheel cut-outs
- Aesthetics
- Signs may be unwelcome by adjacent residents
- Increased noise for nearby residents

Speed Cushion

Speed cushions are constructed from durable recycled rubber and are a variation of the speed lump. These prefabricated devices consistently have a more uniform shape than asphalt humps. Speed cushions provide wheel gaps for emergency vehicles and buses, and can be arranged to fit any street width. They can also be easily relocated if needed.

The magnitude of speed reduction is dependent on the spacing of speed cushions between points that require drivers to slow (see page 56). On average, speed cushions achieve a 14 percent reduction in speeds.

Approximate Cost: \$4,500 - \$6,000 per location

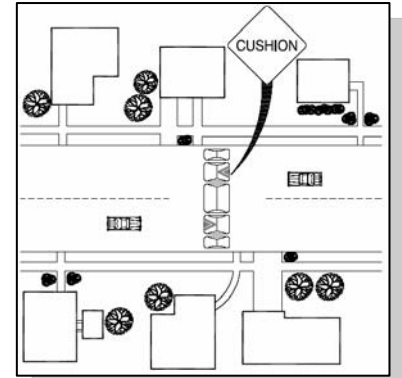

Measured Effectiveness		
Speed Reduction	Reduction in 85th Percentile Speeds between Slow Points	-14%
Volume Reduction	Reduction in Average Daily Traffic	Comparable to Speed Lumps
Safety Reduction	Reduction in Average Annual Number of Collisions	
Source: City of Portland, Rubber Speed Bump Research, 1995.		



Advantages

- Provides a more consistent ride than asphalt humps
- Can be used as a temporary device during a testing phase
- Reduces impacts to emergency vehicles due to cut-outs
- Easily accommodates street resurfacing

Disadvantages

- Aesthetics
- Signs may be unwelcome by adjacent residents
- Increased noise for nearby residents

Speed Table

Speed tables are flat-topped speed humps approximately 22 feet long. They are typically long enough for the entire wheelbase of a passenger car to rest on top. Their long, flat fields, plus ramps that are more gently sloped than speed humps, give speed tables higher design speeds than humps, and, thus, may be more appropriate for streets with higher ambient speeds. Brick or other textured materials improve the appearance of speed tables, draw attention to them, and may enhance safety and speed reduction.

The magnitude of speed reduction is dependent on the spacing of speed tables between points that require drivers to slow (see page 56). On average, speed tables achieve an 18 percent reduction in speeds.

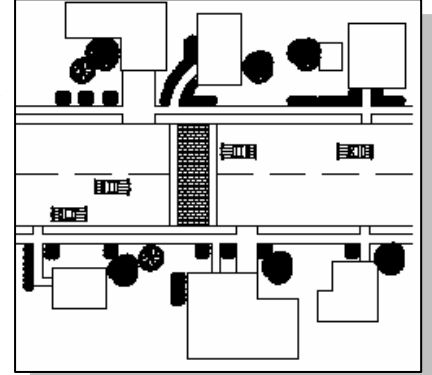

Approximate Cost: \$4,000 for basic treatment

Measured Effectiveness		
Speed Impacts	Reduction in 85th Percentile Speeds between Slow Points	-18%
Volume Impacts	Reduction in Vehicles per Day	-12%
Safety Impacts	Reduction in Average Annual Number of Collisions	-45%
Source: Traffic Calming: State of the Practice, 2000.		



Advantages

- Smoother on large vehicles (such as fire trucks) than speed humps
- Effective in reducing speeds, though not to the extent of speed humps

Disadvantages

- Aesthetics
- Textured materials, if used, can be expensive
- Signs may be unwelcome by adjacent residents
- Increased noise for nearby residents

Raised Crosswalk

Raised crosswalks are speed tables striped with crosswalk markings and signage to channelize pedestrian crossings, providing pedestrians with a level street crossing. Also, by raising the level of the crossing, pedestrians are more visible to approaching motorists.

The magnitude of speed reduction is dependent on the spacing of raised crosswalks between points that require drivers to slow (see page 56). On average, raised crosswalks achieve an 18 percent reduction in speeds.

Approximate Cost: \$5,000 for basic treatment

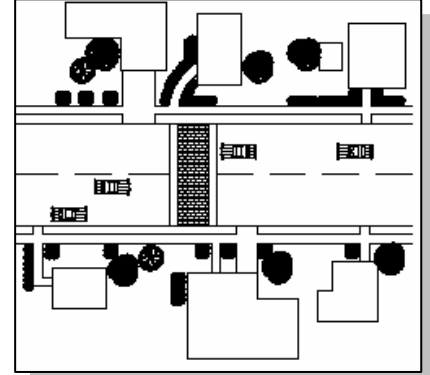

Measured Effectiveness		
Speed Impacts	Reduction in 85th Percentile Speeds between Slow Points	-18%
Volume Impacts	Reduction in Vehicles per Day	-12%
Safety Impacts	Reduction in Average Annual Number of Collisions	-45%
Source: Traffic Calming: State of the Practice, 2000.		



Advantages

- Improve safety for both vehicles and pedestrians
- Aesthetic upgrades can have positive aesthetic value
- Effective in reducing speeds, though not to the extent of speed humps

Disadvantages

- Textured materials, if used, can be expensive
- Impact to drainage needs to be considered
- Textured pavement can increase noise to adjacent residents
- Signs may be unwelcome by adjacent residents

Raised Intersection

Raised intersections are flat raised areas covering entire intersections, with ramps on all approaches. They usually rise to sidewalk level, or slightly below, to provide a “lip” for the visually impaired. By modifying the level of the intersection, the crosswalks are more readily perceived by motorists to be a pedestrian area. They are particularly useful where loss of on-street parking due to other traffic calming devices is considered unacceptable. Raised intersections are ineffective at reducing traffic speeds or volumes.

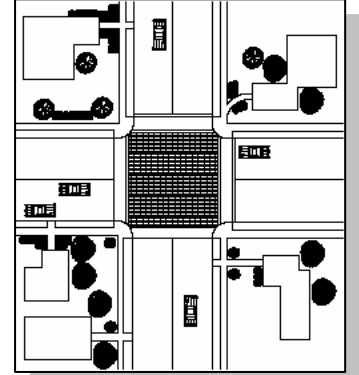

Approximate Cost: Varies based on size of intersection

Measured Effectiveness		
Speed Reduction	Reduction in 85th Percentile Speeds between Slow Points	-1%
Volume Reduction	Reduction in Average Daily Traffic	I/D
Safety Reduction	Reduction in Average Annual Number of Collisions	I/D
Note: I/D = Insufficient Data to predict reduction effect. Source: Traffic Calming: State of the Practice, 2000.		

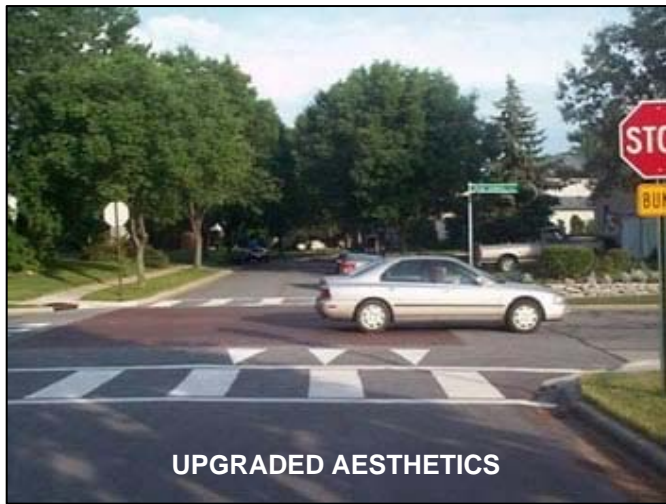

Advantages

- Can improve safety for pedestrians and motorists
- Aesthetic upgrades can have positive aesthetic value
- Can treat two streets at once

Disadvantages

- Less effective in reducing vehicle speeds than speed humps and speed tables
- Expensive, particularly as a retrofit
- Textured pavement can increase noise to adjacent residents

Textured/Colored Pavement

Textured colored pavement includes the use of stamped pavement (asphalt) or alternate paving materials to create an uneven surface for vehicles to traverse. Textured pavement may have limited effectiveness as a standalone device and should be used to supplement other devices such as raised crosswalks or center median islands. Little data has been collected to predict the reduction in speed, traffic volumes, or collisions, and use of this device may not result in significant decreases. Resources permitting, DES staff can collect before and after data to determine the effectiveness of textured pavement.

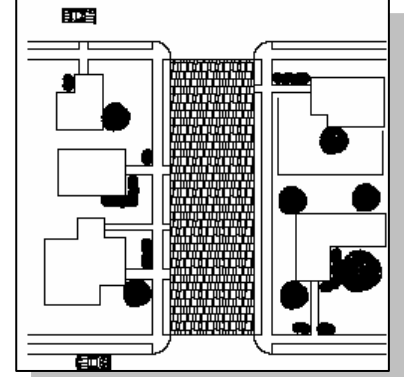

Approximate Cost: \$8.00 per square foot

Measured Effectiveness		
Speed Reduction	Reduction in 85th Percentile Speeds between Slow Points	I/D
Volume Reduction	Reduction in Average Daily Traffic	I/D
Safety Reduction	Reduction in Average Annual Number of Collisions	I/D
Note: I/D = Insufficient Data to predict reduction effect.		



Advantages

- Can reduce vehicle speeds
- Aesthetic upgrades can have positive value
- Placed at an intersection, it can slow two streets at once

Disadvantages

- Expensive, varying by materials used
- Can be uncomfortable for bicyclists or handicapped.
- Textured pavement can increase noise to adjacent properties

Rumble Strip

Rumble strips are closely spaced raised pavement markers at regular intervals on the roadway that create noise and vibration to the vehicle. Rumble strips can be used to warn drivers of a change in speed limit, leading up to a residential or school area, and upcoming stop sign or intersection. Rumble strips should be used only in areas where the noise impact would be minimal. Little data has been collected to predict the reduction in speed, traffic volumes, or collisions, and use of this device may not result in significant decreases. Resources permitting, DES staff can collect before and after data to determine the effectiveness of rumble strips.

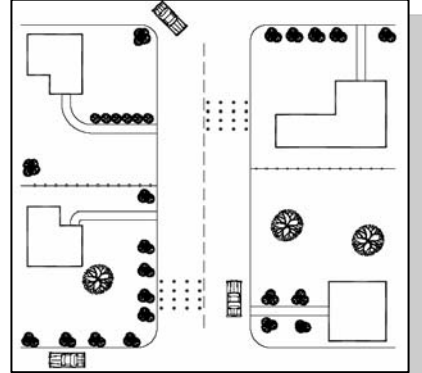

Approximate Cost: \$500 per location

Measured Effectiveness		
Speed Reduction	Reduction in 85th Percentile Speeds between Slow Points	I/D
Volume Reduction	Reduction in Average Daily Traffic	I/D
Safety Reduction	Reduction in Average Annual Number of Collisions	I/D
Note: I/D = Insufficient Data to predict reduction effect.		



Advantages

- Relatively inexpensive
- Can be effective in slowing travel speeds in specific locations

Disadvantages

- Raised pavement markers can be slippery when wet
- Increased noise in vicinity of rumble strips
- Maintenance of raised pavement markers
- Aesthetics
- Uncomfortable for motorcyclists and bicyclists

VOLUME CONTROL – DEVICES

Description

Diversion devices use raised islands and curb extensions to physically preclude particular vehicle movements, such as left-turn or through movements, usually at an intersection. These devices can be considered only after all other devices have been attempted and failed to resolve the traffic problem. The diversion devices in the toolbox include:

- Full Closure
- Partial Closure
- Diagonal Diverter
- Median Barrier
- Forced Turn Island
- Turn-Movement Restriction

Full Closure

Full street closures are barriers placed across a street to close the street completely to through traffic, usually leaving only sidewalks or bicycle paths open. The barriers may consist of landscaped islands, walls, gates, side-by-side bollards, or any other obstructions that leave an opening smaller than the width of a passenger car. Emergency vehicles can be accommodated via removable bollards or similar devices.

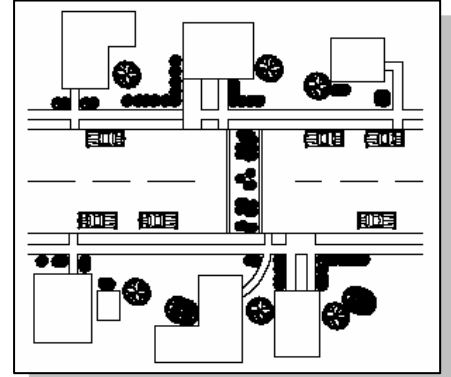

Approximate Cost: \$50,000 - \$100,000 per location (dependent on size and treatment)

Measured Effectiveness		
Speed Reduction	Reduction in 85th Percentile Speeds between Slow Points	I/D
Volume Reduction	Reduction in Vehicles per Day	-44%
Safety Reduction	Reduction in Average Annual Number of Collisions	I/D
Note: I/D = Insufficient Data to predict reduction effect. Source: Traffic Calming: State of the Practice, 2000.		



Advantages

- Very effective in reducing cut-through traffic volumes
- Able to maintain pedestrian and bicycle connectivity

Disadvantages

- Requires statutory actions for public street closures
- Causes circuitous routes for local residents
- Diverts traffic to another street
- Delays for emergency services unless through access is provided
- May limit access to businesses
- Cost

Partial Closure

Half street closures are barriers that block travel in one direction for a short distance on otherwise two-way streets. Half closures are the most common volume control measure after full street closures. Half closures are often used in sets to make travel through neighborhoods with a grid street pattern circuitous rather than direct.

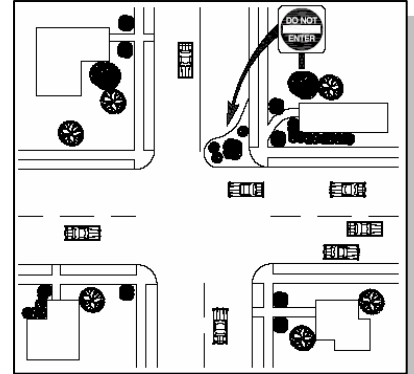

Approximate Cost: \$5,000 - \$7,000 per location

Measured Effectiveness		
Speed Reduction	Reduction in 85th Percentile Speeds between Slow Points	-19%
Volume Reduction	Reduction in Vehicles per Day	-42%
Safety Reduction	Reduction in Average Annual Number of Collisions	I/D
Note: I/D = Insufficient Data to predict reduction effect. Source: Traffic Calming: State of the Practice, 2000.		



Advantages

- Able to maintain two-way bicycle access
- Effective in reducing traffic volumes

Disadvantages

- Causes circuitous routes for local residents
- May limit access to businesses
- Drivers can bypass the barrier

Diagonal Diverter

Diagonal diverters are barriers placed diagonally across an intersection, blocking through movement. Like half closures, diagonal diverters are usually staggered to create circuitous routes through neighborhoods.

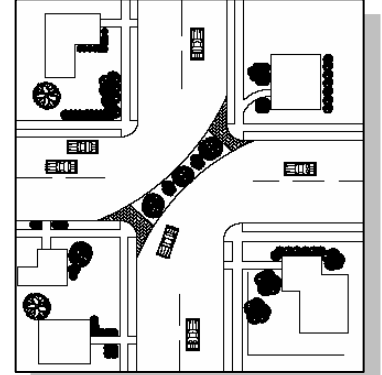

Approximate Cost: \$20,000 - \$25,000 per location

Measured Effectiveness		
Speed Reduction	Reduction in 85th Percentile Speeds between Slow Points	-4%
Volume Reduction	Reduction in Vehicles per Day	-35%
Safety Reduction	Reduction in Average Annual Number of Collisions	I/D
Note: I/D = Insufficient Data to predict reduction effect.		
Source: Traffic Calming: State of the Practice, 2000.		



Advantages

- Able to maintain full pedestrian and bicycle access
- Reduces traffic volumes

Disadvantages

- Causes circuitous routes for local residents
- Delays for emergency services
- May be expensive
- May require reconstruction of corner curbs

Median Barrier

Median barriers are raised islands that are located along the centerline of a street and continue through an intersection so as to block through (and left-turn) movement at a cross street.

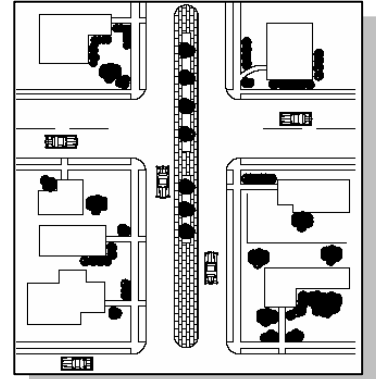

Approximate Cost: \$15,000 - \$20,000 per 100 feet (dependent on length and width)

Measured Effectiveness		
Speed Reduction	Reduction in 85th Percentile Speeds between Slow Points	I/D%
Volume Reduction	Reduction in Vehicles per Day	-31%
Safety Reduction	Reduction in Average Annual Number of Collisions	I/D
Note: I/D = Insufficient Data to predict reduction effect.		
Source: Traffic Calming: State of the Practice, 2000.		



Advantages

- Can improve safety at an intersection of a local street and a major street by prohibiting critical through or left-turn movements
- Can reduce traffic volumes on a cut-through route that crosses a major street

Disadvantages

- Requires available street width on the major street
- Limits turns to and from the side streets and driveways for local residents and emergency services

Forced-Turn Island

Forced turn islands are raised islands that prohibit certain movements on approaches to an intersection.

Approximate Cost: \$3,000 - \$5,000 per location

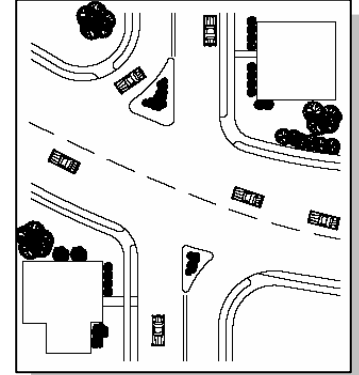

Measured Effectiveness		
Speed Reduction	Reduction in 85th Percentile Speeds between Slow Points	I/D%
Volume Reduction	Reduction in Vehicles per Day	-31%
Safety Reduction	Reduction in Average Annual Number of Collisions	I/D
Note: I/D = Insufficient Data to predict reduction effect. Source: Traffic Calming: State of the Practice, 2000.		



BASIC TREATMENT



STANDARD TREATMENT

Advantages

- Can improve safety at an intersection by prohibiting critical turning movements
- Reduces traffic volumes

Disadvantages

- If designed improperly, drivers can maneuver around the island to make an illegal movement
- May divert a traffic problem to a different street

Turn-Movement Restrictions

Turn movement restrictions involve the use of signs to prevent undesired turning movements without the use of physical devices. The restrictions may generally apply to turning movements in or out of a residential street to a larger street. The turn movement restrictions may be permanent or only during peak commute hours.

Measured Effectiveness		
Speed Reduction	Reduction in 85th Percentile Speeds between Slow Points	I/D
Volume Reduction	Reduction in Vehicles per Day	I/D
Safety Reduction	Reduction in Average Annual Number of Collisions	I/D
Note: I/D = Insufficient Data to predict reduction effect.		

Approximate Cost: \$150 per sign (enforcement may be necessary to be effective)



Advantages

- Can reduce cut-through traffic at specific times of day
- Can increase safety at an intersection by prohibiting certain turning movements
- Low cost

Disadvantages

- Restrictions apply to resident and non-residents
- Requires enforcement during time of restriction to be effective
- May divert a traffic problem to another street

4. TOOLBOX GUIDELINES

This section provides guidance on selecting the most appropriate neighborhood traffic management measure for a specific problem. This involves narrowing the toolbox of neighborhood traffic management measures to those that will most closely target the key traffic issue; are appropriate for the existing street characteristics; and are compatible with the traffic volumes, geometrics, and adjacent land uses near the given location. When the list has been narrowed, devices should be considered that are likely supported by affected residents. Finally, the selected devices need to be placed in a manner that will produce the desired results.

GUIDELINES

Step 1 – Identify Traffic Related Concern

The first task when selecting the most appropriate traffic calming device is to narrow the field of devices to those that address the primary traffic concern. The most common traffic related concerns are:

- Speeding – motor vehicle speeds are too high
- Traffic Volumes – motor vehicle usage levels (all trips or non-local trips only) are too high
- Safety – locations with higher occurrences of collisions, higher concentrations of bicyclists and pedestrians, or potential hazards (e.g., sight distance limitations)

Each device in the toolbox is appropriate to a different subset of the above traffic-related concerns. Table 1 summarizes the appropriateness of each device.

Non-Physical Measures

The first solutions to consider should be non-physical measures, such as signs and markings, since these can devices increase driver awareness, are relatively inexpensive, and are the least intrusive to residents.

Speed Control Measures

Speed control measures can address any of the major problem types:

- ***Narrowing Measures*** – Narrowing devices, such as neckdowns, center island narrowings, or chokers, are less obtrusive than other devices and can be more aesthetically pleasing if residents opt to fund upgraded landscaping and assume the maintenance cost and responsibilities.
- ***Horizontal Measures*** – Horizontal deflection devices, such as chicanes and traffic circles, are more intrusive but also more effective than narrowings because they force vehicles to navigate horizontally around physical objects. Residents can also elect to fund upgraded landscaping.
- ***Vertical Measures*** – Vertical deflection devices provide the greatest speed reduction, and consequently have the greatest potential to slow emergency response vehicles, buses, and trucks. Therefore, the placement of these devices should be carefully considered, especially to limit any potential impact on emergency vehicles or transit access.

Volume Control Measures

If speed-control measures fail to produce desired results, then diversion measures, such as street closures or forced turns may be considered. These devices redirect traffic to an adjacent street, and, therefore, should be considered after all other measures fail to produce the desired results. Volume control measures limit through traffic or turning movements at specific locations for both residents and non-residents. The full effect of the traffic diversion should be investigated before device implementation.

Step 2 – Identify Location Type

The appropriate device for a given problem is a function of the location (midblock or at an intersection). Special consideration will be given to streets used by the City of Salinas Fire Department or ambulance services as primary emergency response routes. Appendix D presents the City of Salinas Primary Fire Response routes with functional roadway classifications. Generally, traffic calming of emergency response routes is limited to non-physical treatments on major arterials; however, there are certain conditions for which traffic calming measures may be appropriate on emergency response routes classified as minor arterials and collectors.

Table 2 indicates the location(s) where each type of traffic calming measure is applicable.

Step 3 – Consider Street Classification, Location, and Other Constraints

The third step in determining the most appropriate device is to consider how each device is compatible with the street classification, traffic volumes, posted speeds, and special roadway users. Table 3 illustrates where each device is appropriate with certain constraints.

EFFECTIVENESS COMPARISON

When more than one traffic calming device is available, decision-makers should understand the levels of effectiveness for each device to better determine which device will have the greatest effect in meeting the specified objective(s). Table 4 summarizes the effectiveness data (including excluded devices) that have been compiled for each of the neighborhood traffic management measures in the toolbox. These data are averages and the actual effectiveness will vary based on site-specific circumstances, such as proximity to major roads and the availability of alternate routes.

PLACING THE NEIGHBORHOOD TRAFFIC MANAGEMENT MEASURES

Strategies for the specific placement of devices differ depending on whether the concern is speed-control, volume-control, or safety related. The placement of devices is described below.

Placing Speed-Control Measures

Where feasible, neighborhood traffic management measures should be spaced in such a way to achieve the following two design speeds:

- **Slow-Point 85th Percentile Design Speed:** the speed that 85 percent of vehicles are traveling less than, when they are crossing a neighborhood traffic management device; the target slow-point speed is defined as 5 mph below the posted speed limit.
- **Midpoint 85th Percentile Design Speed:** the speed that 85 percent of vehicles are traveling less than, when they are halfway between a traffic calming device or other roadway feature that requires

significant slowing (e.g., stop sign or curve). The target midpoint speed is defined as 5 mph above the posted speed limit.

Figure 3 illustrates how to estimate the midpoint speed.

TABLE 1 APPLICABILITY OF TREATMENTS BY TRAFFIC RELATED CONCERN						
Types of Measures	Type of Traffic Related Concern					
	Speeding	Traffic Volume	Vehicle Collisions	Pedestrian Safety	Noise	
Non-Physical Control Measures						
Targeted Speed Enforcement	●	○	◐	◐	◐	
Speed Radar Trailer	●	○	○	○	◐	
Speed Feedback Sign	●	○	○	○	◐	
Centerline/Edgeline Lane Striping	●	○	○	○	○	
Optical Speed Bars	◐	○	○	○	○	
Signage	●	◐	◐	○	○	
Speed Legend	●	○	○	○	○	
Centerline/Edgeline Reflectors	○	○	●	◐	○	
High Visibility Cross Walks	◐	○	○	●	○	
Angled Parking	●	◐	○	○	○	
Speed Control – Narrowing Measures						
Neckdown/Bulbout	●	◐	○	●	○	
Center Island Narrowing/ Pedestrian Refuge	●	◐	◐	●	○	
Two-Lane Choker	●	◐	○	○	○	
One-Lane Choker	●	◐	○	○	○	
Speed Control - Horizontal Measures						
Traffic Circle	●	◐	●	◐	○	
Roundabout (Single-Lane)	◐	◐	●	○	●	
Chicane	●	◐	○	○	○	
Lateral Shift	◐	◐	○	○	○	
Realigned Intersection	◐	◐	●	○	○	
Speed Control – Vertical Measures						
Speed Hump	●	●	◐	◐	×	
Speed Lump	●	●	◐	◐	×	
Speed Cushion	●	●	◐	◐	×	
Speed Table	●	◐	◐	◐	×	
Raised Crosswalk	●	◐	◐	●	×	
Raised Intersection	●	◐	◐	●	×	
Textured/Colored Pavement	◐	○	○	◐	×	
Rumble Strips	◐	○	○	○	×	
Volume Control Measures						
Full Closure	●	●	○	○	○	
Partial Closure	●	●	○	○	○	
Diagonal Diverter	●	●	○	○	○	
Median Barrier	○	●	◐	○	○	
Forced Turn Island	○	●	◐	○	○	
Turn-Movement Restriction	○	●	◐	○	○	
Key:	● = Strongly Appropriate		× = Inappropriate/Counterproductive			
	◐ = Moderately Appropriate		○ = Indifferent			

**TABLE 2
APPLICABILITY OF TREATMENTS BY LOCATION**

Type of Measure	Mid-Block	Intersection	Study Perimeter	Collectors	Transit Routes
Non-Physical Control Measures					
Targeted Speed Enforcement	●	●	●	●	●
Speed Radar Trailer	●	●	●	●	●
Speed Feedback Sign	●	●	●	●	●
Centerline/Edgeline Lane Striping	●	x	x	●	●
Optical Speed Bars	●	x	x	●	●
Signage	●	●	●	●	●
Speed Legend	●	●	●	●	●
Centerline/Edgeline Reflectors	On Curves	x	x	●	●
High Visibility Crosswalks	●	Unsignalized Intersections	Unsignalized Intersections	●	●
Angled Parking	●	x	x	●	○
Speed Control – Narrowing Measures					
Neckdown/Bulbout	x	●	●	●	●
Center Island Narrowing/ Pedestrian Refuge	●	●	●	●	●
Two-Lane Choker	●	x	x	●*	●
One-Lane Choker	●	x	x	x	x
Speed Control – Horizontal Measures					
Traffic Circle	x	●	○	●	●
Roundabout (Single-Lane)	x	○	○	●	●
Chicane	●	x	x	●	●
Lateral Shift	●	x	x	●	●
Realigned Intersection	x	Unsignalized Intersections	Unsignalized Intersections	●	●
Speed Control – Vertical Measures					
Speed Hump	●	x	x	○*	x
Speed Lump	●	x	x	○	●
Speed Cushion	●	x	x	○	●
Speed Table	●	x	x	○	○
Raised Crosswalk	●	○	○	○	○
Raised Intersection	x	●	●	○	○
Textured/Colored Pavement	●	●	●	●	●
Rumble Strips	●	●	○	●	●
Volume Control Measures					
Full Closure	x	●	●	○*	x
Partial Closure	x	●	●	●	●
Diagonal Diverter	x	●	x	○*	x
Median Barrier	x	○	●	○*	x
Forced Turn Island	x	○	●	○	○
Turn-Movement Restriction	x	○	●	○	○
Key: * Not generally acceptable for Primary Fire Response Routes – See Appendix D for specific streets.					
x = Never applicable. ○ = Seldom, except in some cases. ● = Generally applicable.					

**TABLE 3
APPLICABILITY BY STREET TYPE**

Types of Measures	Roadway Classification		
	Local	Collector	Other Considerations
Non-Physical Control Measures			
Targeted Speed Enforcement			None
Speed Radar Trailer			
Speed Feedback Sign	No		
Centerline/Edgeline Lane Striping			
Optical Speed Bars	No Limitations with respect to ADT or Speed		
Signage			
Speed Legend			
Centerline/Edgeline Reflectors			
High Visibility Crosswalks			
Angled Parking	ADT <4,000; Width ≥48 feet: Speed Limit ≤30 mph		
Speed Control – Narrowing Measures			
Neckdown/Bulbout			None
Center Island Narrowing/ Pedestrian Refuge	ADT ≤ 20,000; Speed Limit ≤ 35		
Two-Lane Choker			
One-Lane Choker	ADT ≤ 3,000; Speed Limit ≤ 30	No	DES must review sight distance.
Speed Control – Horizontal Measures			
Traffic Circle	Daily Entering Volume <10,000; Speed Limit ≤ 35 mph		Grades ≤ 4%
Roundabout (Single-Lane)	No	Daily Entering Volume <16,000; Speed Limit ≤ 45 mph	
Chicane	No	ADT ≤ 5,000; Speed Limit ≤ 35	Grades ≤ 8%
Lateral Shift	No	ADT ≤ 20,000; Speed Limit ≤ 35	None
Realigned Intersection	Daily Entering Volume <5,000; Speed Limit ≤ 35 mph		
Speed Control – Vertical Measures			
Speed Hump	ADT <4,000; Speed Limit ≤ 30mph		Grades ≤ 8%
Speed Lump			
Speed Cushion	ADT <7,500: Speed Limit 30 mph or 35 mph		
Speed Table ¹			
Raised Crosswalk			
Raised Intersection	No		
Textured/Colored Pavement ²	No	Yes	Noise impact to adjacent residential units
Rumble Strips ²	Yes	Yes	Noise impact to adjacent residential units
Notes: ¹ Not appropriate for streets without curbs, gutter, or sidewalks. ² Use of this device should be limited to locations where noise impacts would be minimal.			

TABLE 3 (CONTINUED) APPLICABILITY BY STREET TYPE			
Types of Measures	Roadway Classification		
	Local	Collector	Other Considerations
Volume Control Measures			
Full Closure		No	None
Partial Closure	≥ 25% non-local traffic. Evaluation should be conducted to determine effects of diverted traffic to alternate routes		
Diagonal Diverter			
Median Barrier			
Forced Turn Island			
Turn-Movement Restriction			

**TABLE 4
QUANTITATIVE IMPACTS OF NEIGHBORHOOD TRAFFIC MANAGEMENT MEASURES**

Types of Measures	Effectiveness										
	85 th Percentile Change				Vehicles Per Day		Average Annual Collisions				
	Before	After	Change	Percent Change	Change	Percent Change	Before	After	Change	Percent Change	
Non-Physical Measures											
All Non-Physical Measures	Limited Effectiveness as stand alone device										
Speed Control – Vertical Measures											
Entry Feature	I/D				I/D		I/D				
Speed Hump	35.0	27.4	-7.6	-22%	-355	-18%	2.62	2.29	-0.33	-13%	
Speed Lump	Comparable to speed hump but I/D										
Speed Cushion ¹	Comparable to speed hump but I/D			-14%	Comparable to speed hump but I/D						
Split Speed Hump	37	32	-5	-14%	I/D		I/D				
Speed Table	36.7	30.1	-6.6	-18%	-415	-12%	6.71	3.66	-3.05	-45%	
Raised Crosswalk	Ineffective										
Raised Intersection	34.6	34.3	-0.3	-1%	Ineffective						
Textured Pavement	Limited Effectiveness as stand alone device										
Rumble Strips	I/D and Limited Effectiveness										
Speed Control – Narrowing Measures											
Neckdown/Bulbout	I/D										
Center Island Narrowing	34.9	32.3	-2.6	-7%	-293	-10%	I/D				
Two-Lane Choker	I/D										
One-Lane Choker	I/D			-14%	I/D	-20%	I/D				
Speed Control – Horizontal Measures											
Traffic Circle	34.2	30.3	-3.9	-11%	-293	-5%	2.19	0.64	-1.55	-71%	
Roundabout (Single-Lane)	Insignificant Speed Effects				Insignificant Volume Effects		Not Recorded			-15% to -33%	
Chicane	I/D and Limited Effectiveness										
Lateral Shift	Ineffective										
Realigned Intersection	I/D				I/D		I/D				
Volume Control Measures											
Full Closure	I/D	I/D	I/D	I/D	-671	-44%	I/D				
Partial Closure	32.3	26.3	-6.0	-19%	-1,611	-42%	I/D				
Diagonal Diverter	29.3	27.9	-1.4	-4%	-501	-35%	I/D				
Median Barrier	I/D										
Forced Turn Island	I/D				I/D		I/D				
Turn-Movement Restrictions	I/D										
Stop Signs											
Stop Signs	I/D				I/D		I/D				
Notes: I/D = Insufficient Data											
Source: Traffic Calming State-of-the Practice (Ewing, 1999)											
¹ City of Portland, Rubber Speed Bump Research, 1995											

Figure 3 Estimating Midpoint Speed

In mathematical terms, the following exponential function gives the relationship between midpoint speed and spacing of slow points:

$$85^{\text{th}}_{\text{midpoint}} (\text{mph}) = 85^{\text{th}}_{\text{slow point}} (\text{mph}) + (85^{\text{th}}_{\text{street}} (\text{mph}) - 85^{\text{th}}_{\text{slow point}} (\text{mph})) * 0.56 * (1 - e^{-0.004 * \text{spacing (ft.)}})$$

where;

$85^{\text{th}}_{\text{midpoint}}$ = resulting 85th percentile speed at midpoint after treatment;

$85^{\text{th}}_{\text{slow point}}$ = estimated 85th percentile speed at the slow point after treatment;

$85^{\text{th}}_{\text{street}}$ = 85th percentile speed of street before treatment;

spacing = distance in feet between two devices.

When placing speed-control measures, use the above formula to test proposed spacings to determine whether the estimated midpoint speeds would meet the targeted midpoint speed.

Example (speed humps on street with starting speed of 32 mph):

Where spacing is 350 feet:

$$85^{\text{th}}_{\text{midpoint}} (\text{mph}) = 15 \text{ mph} + ((32 \text{ mph} - 15 \text{ mph}) * 0.56 * (1 - e^{-0.004 * 350 \text{ feet}}))$$

$$85^{\text{th}}_{\text{midpoint}} (\text{mph}) = \underline{22 \text{ mph}}$$

Where spacing is 750 feet:

$$85^{\text{th}}_{\text{midpoint}} (\text{mph}) = 15 \text{ mph} + ((32 \text{ mph} - 15 \text{ mph}) * 0.56 * (1 - e^{-0.004 * 750 \text{ feet}}))$$

$$85^{\text{th}}_{\text{midpoint}} (\text{mph}) = \underline{24 \text{ mph}}$$

The spacing of neighborhood traffic management measures directly affects the midpoint speeds: the farther apart they are, the higher the midpoint speed. In general, speed control measures placed 350 to 750 feet from another slow-point can result in speed reductions similar to those indicated in Table 4. Measures placed at intervals of less than 350 feet can become a nuisance to drivers, and measures placed greater than 750 feet apart decrease the ability to slow speeds to the target midpoint speed. In addition, vertical measures should be placed a minimum of 250 feet from an adjacent intersection.

Placing Volume-Control Measures

Neighborhood traffic management devices intended to divert traffic can be located either external or internal to the neighborhood.

- Gateway Measures – Volume-control measures placed at entrances or gateways to neighborhoods can be more effective in reducing volumes because drivers encounter these devices upon entering a neighborhood, which may deter future use. However, these measures can also cause local traffic to take more circuitous paths than internal measures would.
- Internal Measures – When placed within a neighborhood, measures have a less direct effect on non-local traffic. First-time attempts to travel through the neighborhood will occur more frequently, and drivers will seek alternative routes within the neighborhood. However, this type of placement can cause less of an inconvenience to local traffic.

Placing Safety Measures

The placement of safety-oriented neighborhood traffic management devices is dependent on the particulars of the traffic-related concern and on the characteristics of the selected neighborhood traffic management device. For example, if the traffic related concern involves pedestrian safety, then the solution – a raised crosswalk, for example – should be placed at a location where it is likely to be heavily used by pedestrians.

5. NEW DEVELOPMENT GUIDELINES

Proposed developments can benefit from neighborhood traffic management strategies. Developers can anticipate and prevent concerns about speeding and traffic volumes by reviewing neighborhood plans and proposing refinements to reduce or avoid future traffic-related concerns. In addition, neighborhood traffic management measures incorporated with project construction often receive greater acceptance than a retrofit approach. Traffic calming measures can be included as off-site mitigation measures for infill or redevelopment projects that are surrounded by existing developments that may be impacted by project traffic.

This information in this chapter is a tool for staff and project designers to identify potential problem areas and suggested remedies. Anticipating future problems and remedies is a subjective activity, not conducive to absolute standards. However, it may be appropriate to incorporate general language into City documents regarding the role of staff in identifying potential neighborhood traffic problems and suggesting remedies.

In most cases, staff and the developer's representatives should be able to identify mutually acceptable neighborhood traffic management features, which are then incorporated into the proposed plans. However, in some cases, staff may need to develop conditions-of-approval that can be discussed, modified, and/or approved by the relevant governing bodies.

SUGGESTED DEVELOPMENT REVIEW PROCESS

As part of the City of Salinas development review process, City staff may consider the need for neighborhood traffic management measures within the proposed development or off-site. New development and redevelopment projects may be required to design, build, and maintain traffic calming features as part of the development project through the subdivision improvement agreement, development agreement, homeowners' association, and other development-related mechanisms.

The City's process of reviewing new residential subdivisions varies and is dependent on the decision type. Information contained in the development application determines the permit type and subsequent process. Although the processes differ, they all require staff review after the submission of the plans. At this point, City staff may recommend or condition the inclusion of traffic calming measures.

The toolbox and application guidelines contained in other sections of this document should provide staff and developer representatives with both ideas and guidance on selecting the most appropriate treatments for the identified problem.

The following flowchart is a suggested approach for City staff during the development review process.

Figure 4 New Development Review Process

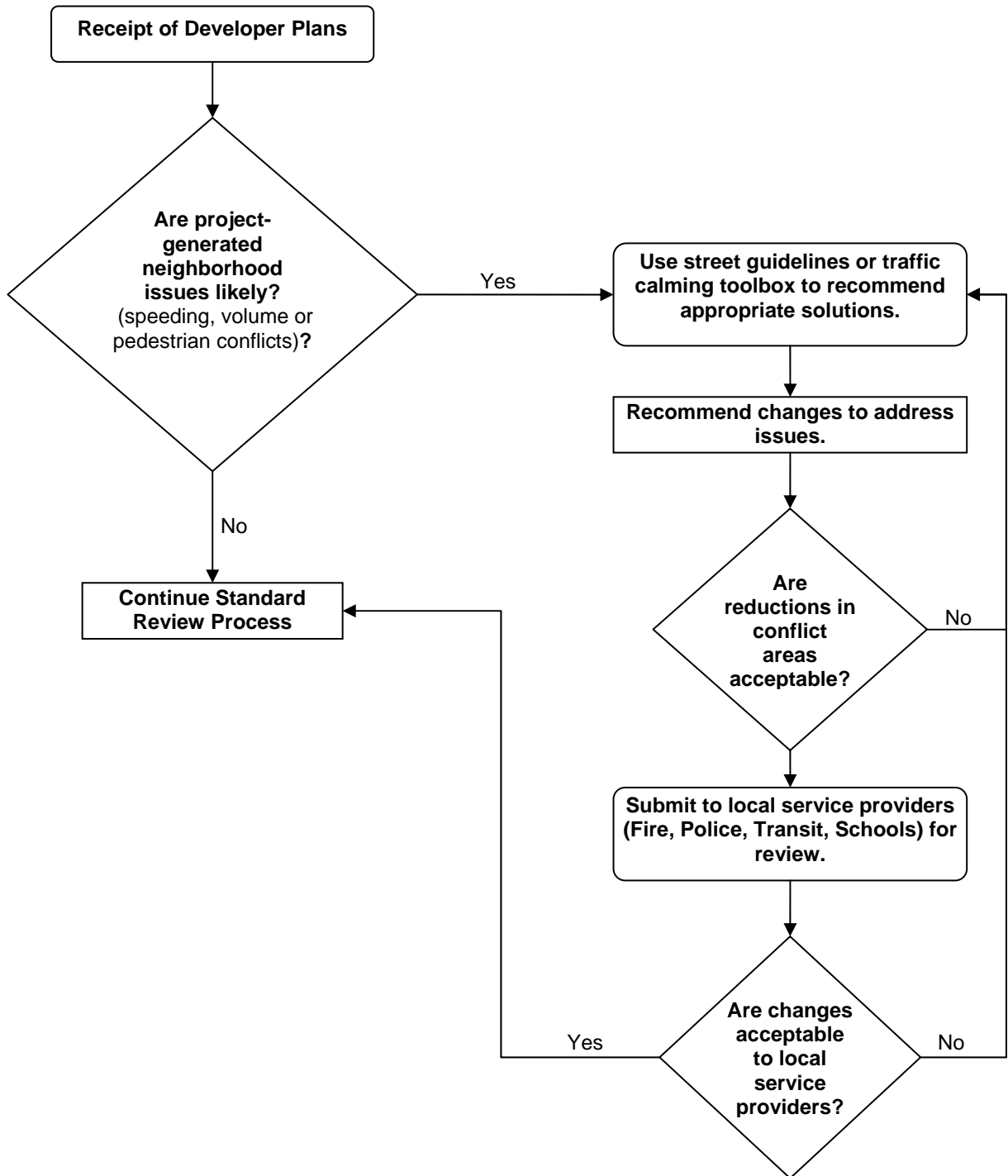

DEVELOPMENT REVIEW PRACTICES

During the development review process, staff should review the street network and intersection traffic controls to determine areas of potential speeding, excessive volume on residential streets, or pedestrian conflict areas. Where appropriate, developers should be required to incorporate traffic calming measures into their development plan. The process for reviewing street and lot plans for new developments and prescribing refinements may include the following, at staff discretion:

- **Traffic Volumes** – Estimate the average daily traffic (ADT) on residential roadways within and surrounding the proposed project.
 - If traffic volumes on residential streets are projected to be less than 1,500 vehicles per day (vpd), then no action is needed, nor will it be taken.
 - If the projected traffic volume on a residential street is 1,500 - 3,000 vpd, then consider traffic calming treatments depending upon the context (such as area history, resident expectations, or magnitude of change).
 - For projected volumes of above 3,000 vpd on a residential street, consider as a priority incorporate traffic calming measures to lessen the impact.
- **Traffic Speeds** – Identify potential speeding concerns on new streets and adjacent existing streets. Potential problem areas may include:
 - Streets with unimpeded block lengths (i.e. slow points) greater than 600 feet between traffic control or traffic calming devices, or as determined by staff.
 - Areas where roadway grades may increase the potential for speeding, as determined by staff.
 - Areas with potential pedestrian/vehicle conflicts, such as schools, parks, or community centers.
 - Areas with design attributes that encourage speeding, such as wide travel lane width, absence of on-street parking lane, absence of a bike lane, and long block lengths.
- **Street Layout** – Staff may request street design and layout modifications if an area is likely to experience cut-through traffic.
- **Adjacent Neighborhoods** – Consider traffic calming measures in new developments where adjacent neighborhoods include traffic calming, as determined by staff.
- **Traffic Calming Plan** – Based on the size and nature of the proposed development, staff will determine if a traffic calming plan is necessary. As described above, a traffic calming plan should be developed when the proposed street layout cannot be modified in such a way that will eliminate foreseeable traffic problems. The applicant's representative should develop the traffic calming plan with DES oversight.

DESIGNING STREET NETWORKS

Neighborhood traffic management measures have traditionally been installed as retrofit measures in existing neighborhoods in response to a particular traffic concern. The guidelines below describe some common street design features and their propensity to lead to neighborhood traffic management concerns such as speeding and cut-through traffic. The guidelines should assist developers in laying out streets in new residential developments and staff in reviewing them pursuant to the process described above. This chapter

is by no means comprehensive on the layout of new residential streets. For detailed information on street design and layout, refer to the following City of Salinas documents:

- City of Salinas General Plan, September 2002
- City of Salinas City Code – Section 31-804.5, November 2006
- Standard Specifications, Design Standards, and Standard Plans – Standard Plan No. 3, 2004

The following documents provide supplemental readings on the subject of designing residential streets. These are guidance documents only:

- *Residential Street Design and Traffic Control*, Homburger, Deakin, Bosselmann, Smith, and Beukers (Institute of Transportation Engineers), 1989
- *Residential Streets*, 3rd Edition, American Society of Civil Engineers, Institute of Transportation Engineers, National Association of Home Builders, and the Urban Land Institute, 2001
- *Traditional Neighborhood Development: Street Design Guidelines*, Institute of Transportation Engineers, 1999

DESIGNING FOR APPROPRIATE SPEEDS

The design of residential streets can often influence vehicles speeds. Residential streets that are wide, long, straight, and have few uninterrupted blocks have been shown to have a positive correlation to higher vehicle speeds. To minimize vehicle speeds, consider the following attributes when designing residential streets:

- **Travel Lane Width** – Current City standards for street width varies depending on the adjacent land use, and presence of on-street parking. Figures C-1 through C-4 of the Salinas General Plan specify standard cross-sections for new and existing streets. Provisions for on-street parking are also provided within these standards. Figure 5 shows a positive correlation between pavement width and increased traffic speeds.³

New streets should not exceed the current City standards. However, if additional width is provided in anticipation of high on-street parking demand, the roadway should be treated with appropriately spaced chokers, center median islands or other neighborhood traffic calming devices.

- **Block Length** – Some street networks leave excessively long blocks with few side street intersections. Drivers who travel distances 600 feet or greater, as illustrated in the chart below, without being required to slow or stop by traffic control or neighborhood traffic management devices, tend to travel at speeds higher than the posted limit. To minimize this effect, the street network can be designed such that street blocks are frequently interrupted by streets of sufficient traffic volumes to warrant a traffic control device (e.g., stop sign) or a traffic calming device. Shorter block lengths also facilitate pedestrian movement throughout the neighborhood. The chart shows the correlation between unimpeded block length and travel speed.

Acceptable block lengths for urban local streets should not exceed 600-800 feet, while urban collector street block lengths should not exceed 1,000 feet.

³ Ballard, Andrew J. and Haldeman, David M. "Low Speed Design Criteria for Residential Streets." *ITE Journal* December 2002: 44-46.

- **Parking Lanes** – In circumstances where adjacent land uses generate low on-street parking demand (such as large-lot subdivisions or collectors without fronting uses) the street can function as if it were wider than intended. If the parking demand can be accommodated elsewhere, the parking lanes should be eliminated or restricted to one side of the street and the street width reduced accordingly.

Figure 5 Correlation Between Pavement Width, Unimpeded Street Length and Speed

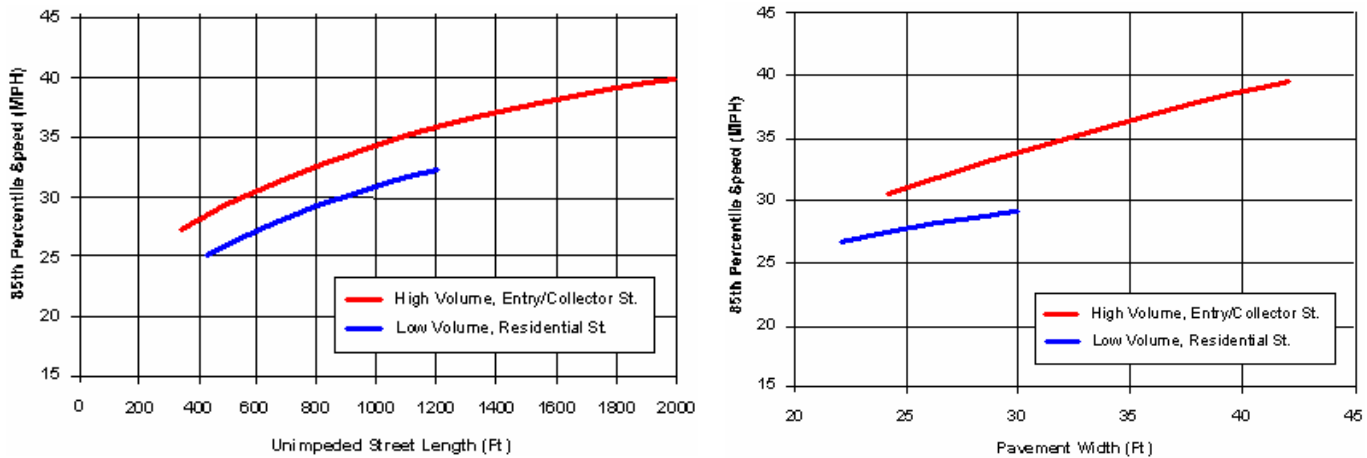

DESIGNING FOR LOCAL TRAFFIC

Some residential collector streets can become cut-through routes, or routes used by non-local motorists as a means of bypassing congested or circuitous arterial roads. In these cases, the residential collector should be modified in one of two ways:

- The collector can be designed with a deviating path so that the overall distance by collector is greater than the distance by arterial.
- The residential roadway network can be designed such that traffic-controlled intersections interrupt the parallel collector route sufficiently that the travel time by collector is greater than the travel time by arterial.

PEDESTRIAN/VEHICLE CONFLICT AREAS

Some elements of residential areas, such as schools, parks, community centers, or other high pedestrian generators, have particularly high potential for vehicle and pedestrian conflicts. The major pedestrian routes to school should be identified and traffic controls should be structured so that the number of crossings at uncontrolled cross-streets is minimized and pedestrians are directed to the most appropriate crossing locations. For both schools and parks, entrances tend to focus pedestrian street crossings at particular locations. These entrances can be made safer by combining them with roadway intersections, so that the intersection's traffic control can also allocate right-of-way to pedestrians.

If a pedestrian-oriented land use is located in an area where speeding or high traffic volumes are unavoidable, then select neighborhood traffic management measures that accommodate and provide benefit to pedestrians. For example, at an intersection, bulbouts or center island narrowings should be given some preference over other measures, such as intersection realignment or speed humps. While a realigned intersection or speed hump may slow traffic in the area, a bulbout or center island narrowing assists

pedestrians by creating a shorter crossing distance and physical roadway narrowing, thereby reducing driver speed.

DEVELOPING A NEIGHBORHOOD TRAFFIC MANAGEMENT PLAN

When a proposed street layout cannot be modified in such a way that will eliminate foreseeable potential traffic problems, the City should require preparation of a neighborhood traffic management plan (NTMP). Follow the procedure for developing an NTMP as described in the Toolbox Chapter, with the following exceptions:

- For speed-related problems, existing travel speed data will not be available. Consequently, a response to anticipated speeding problems must rely on roadway geometry. For example, if a block length is greater than 600 feet, then the developer could use neighborhood traffic management measures to divide the block into segments that are each shorter than 600 feet.
- For volume-related problems, traffic volume data will be available only in the form of traffic forecasts, and these will typically be limited to the major roads. The City or developer may need to prepare manual traffic volume estimates using land use quantities and trip generation rates for the proposed development.
- Anticipated safety problems will likely revolve around land uses that generate pedestrian activity, such as schools, parks, and community centers. For these land uses, consider the planned locations of walkways, gates, and building entrances when placing neighborhood traffic management devices (such as raised crosswalks or bulb-outs). Likewise, land use planning should consider existing and future traffic safety features.
- For some neighborhood traffic management measures, particularly those involving modified curbs, the developer can achieve significant cost-savings by constructing them concurrent with roadway construction. Consequently, when selecting a type of neighborhood traffic management measure, additional preference should be given to measures that take advantage of these cost-savings.

APPENDIX A – DESIGN GUIDELINES

This section describes the guiding design principles relating to various physical traffic calming devices. The design guidelines are based on recommended designs published in *Traffic Calming State-of-the Practice*⁴ and *Canadian Guide to Traffic Calming*⁵. Appendix B contains standard engineering design templates for the most common traffic calming devices.

SPEED CONTROL – VERTICAL MEASURES

Ramp Profiles

Ramp profile describes the angle or approach of the vertical measure that a vehicle would traverse. Vertical measures (e.g., speed humps) should use Parabolic profiles on the approach and departure ramps to the device. Parabolic profiles have consistently been used in other programs around the nation and are a recommended design according to Institute of Transportation Engineers: *Guidelines for the Design & Application of Speed Humps* (ITE, 1993). Figure A-1 shows three commonly used profiles, and a description of each follows below:

- Sinusoidal profiles have slightly less reduction effects on speed than circular and parabolic profiles but higher comfort levels for vehicles and bicyclists and are typically more difficult and expensive to construct due to the slope of the profile.
- Circular profiles have moderate reduction effects on speeds (compared to the two other profiles) and comfort levels for vehicles and bicyclists.
- Parabolic profiles have the greatest reduction effects on speeds but have the lowest comfort levels for vehicles and bicyclists due to the greater rise in the slope of the profile.

Figure A-1 Vertical Measure Ramp Profiles

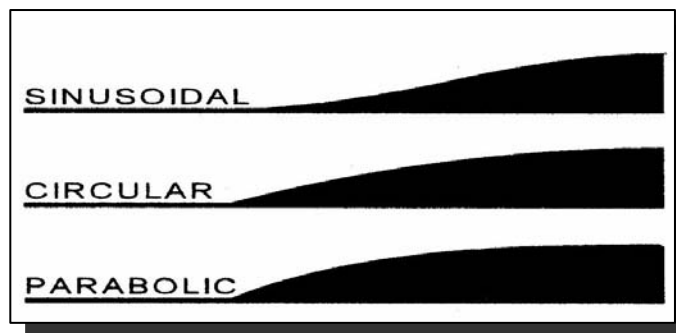

⁴ Ewing, R. (1999). *Traffic Calming: State of the Practice*. Washington, DC: Institute of Transportation Engineers/Federal Highway Administration.

⁵ *Canadian Guide to Neighbourhood Traffic Calming*, (1998) Ottawa, Canada: Transportation Association of Canada.

Edge Tapers

The edge taper refers to the transition area between a vertical measure at its full height and the edge of the device. Edge tapers on vertical measures (e.g., speed humps and excluding raised crosswalks) should extend to the edge of the pavement (i.e., not into the gutter) to prevent blocking the gutter drainage.

On streets without vertical curbs, the edge taper should extend the full length of the pavement width to discourage drivers from straddling or driving around the vertical measure. In addition, an advisory sign (or other barrier) should be placed on either approach of the vertical device to prevent drivers from driving around the device.



Example: Bollards and advisory sign encourage drivers to travel over speed hump.

Edge Tapers – Parking and Bikeways

Vertical devices should extend across any parking or bike lane to prevent drivers from veering into the bike lane. Consequently, bicyclists will traverse the even section (as opposed to the tapered portion) of the device. In addition, vehicles parking on the street will have the option to park on a portion of the device or avoid the device entirely.



Example: Speed lump extends to the edge of pavement across bike lane.

Raised Crosswalk Tapers

Raised crosswalks should always be designed to a height equal to the curb height, but not fully extend to the curb, as this will impede drainage. To bridge the gap between the sidewalk and raised crosswalk, a metal connector plate or other approved device may be used to allow unimpeded flow of the gutter. The design should also include truncated dome plates to indicate the entrance to the crosswalk from the sidewalk. Raised crosswalks may not be appropriate where curbs do not exist.



Example: Unimpeded drainage.

HORIZONTAL DEFLECTION MEASURES

Traffic Circle Center Island Profile

Traffic circles should be designed with both a vertical inner curb and a mountable apron. The vertical inner curb prevents vehicles from driving over the circle. The apron is a shallow-sloped curb extending out from the bottom of a vertical curb; the apron has a low lip at its pavement-side edge. This apron effectively reduces the diameter of the center island for large vehicles, facilitating easier turns. The lip at the apron's edge discourages vehicles from using it unnecessarily.



Example: Vertical inner curb and mountable apron.

Traffic Circle Turn Operations

All vehicles should circulate around the center island on left-turns. However, an exception can be made for large trucks and buses in some cases if geometric constraints require it. If a specific intersection has a high proportion of trucks and/or bus traffic, alternative treatments may provide similar results without impact to trucks or busses. All traffic circles should be designed using the appropriate truck turning templates from Caltrans Highway Design Manual (Caltrans, 2006). Software packages such as AutoCAD or AutoTURN may also be used to identify whether emergency response vehicles and buses can maneuver around the circle.

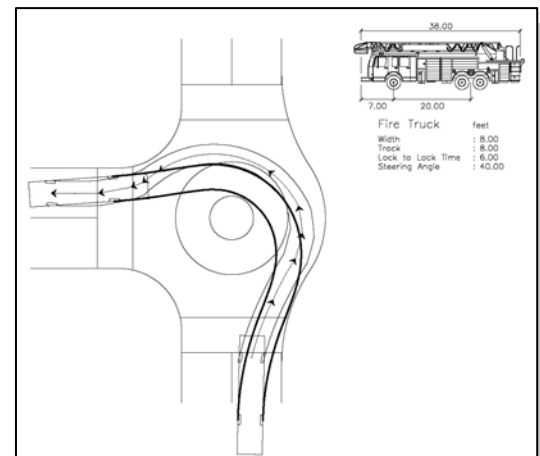

Example: Truck turning radius using mountable apron.

Traffic Circles at T-Intersections

Traffic circles should have deflection on all approaches if implemented at a T-intersection. This can be implemented in both existing neighborhoods in retrofit situations and in new neighborhoods. First, a raised island can be placed at the right side of the un-deflected approach to the traffic circle to artificially introduce deflection, as shown in Figure A-2 (a). In new neighborhoods, the street curbs can be modified to allow the center island to be located at the center of the intersection, as shown in Figure A-2 (b).

Figure A-2 Traffic circles at T-Intersections

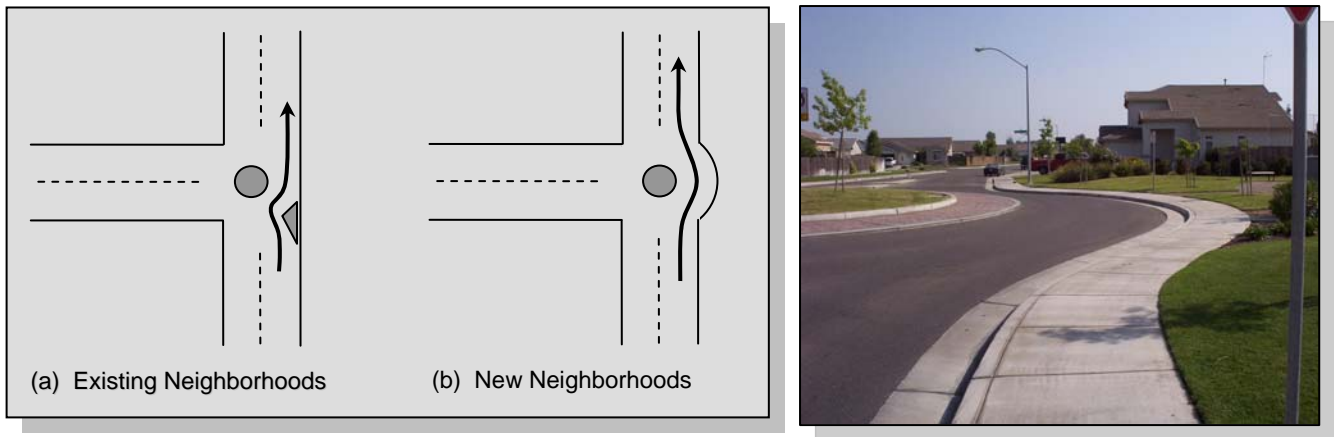

NARROWING MEASURES

Drainage

Narrowing measures, such as chokers, should be constructed to minimize or avoid blocking gutter flow, as illustrated in the photo. Modifying the drainage can be cost prohibitive and could require regular maintenance to clear debris from the modified gutter.



Example: Retrofit design with unimpeded drainage.

Neckdowns/Bulbouts

Narrowing measures, such as neckdowns or chokers, should not be constructed wider than the approximate width of a parked vehicle. Extension of these devices any further than the width of a parked vehicle could present potential safety issues to other drivers.



LANDSCAPING

Example: Neckdown at intersection.

The standard treatment for all neighborhood traffic management devices will be hardscape (i.e., grouted cobblestone). Residents may fund aesthetic upgrades to neighborhood traffic calming devices such as landscaping or stamped and colored concrete (i.e., simulated brick work). Aesthetics upgrades not only improve the aesthetic quality of the device but increase the visual presence of the device. Landscaping should be limited to low-lying shrubs and plants. Trees planted on center islands must allow adequate sight distances for motorists.



Example: Standard treatment



Example: Upgraded aesthetics

SIGNAGE AND STRIPING

Signage

Signage should be provided at or near traffic calming devices advising motorists of the device. Signage should be visible to both motorists and bicyclists. The signs should be comprised mostly of symbols and be easily understandable to motorists. Figure A-3 illustrates examples of several common warning signs.

The warning sign for a traffic circle or roundabout shown on Figure A-3 should be the standard used at such intersections. The warning sign is clear and concise, showing drivers the route around and turning options of the upcoming traffic circle or roundabout.

Special signing specific to bicyclists may be used as determined by Public Works staff. Examples of this signing include advising motorists not to pass bicyclists through narrow traffic calming devices or informing bicyclists of proper maneuvering of devices. This signage should be used when the travel rights of bicyclists warrant emphasis.

Striping

Pavement markings assist in warning motorists and bicyclists of traffic calming devices in the roadway. Vertical devices should always include pavement markings on the device and may also include advanced warning legends (see Figure C-6). In certain situations, vertical devices may be unmarked, such as revitalization or beautification plans in a given area. In such cases, the device must be designed to provide a clear contrast with the surrounding environment.

The example image to the right illustrates the preferred striping option for vertical devices, such as speed humps. This marking option is compliant with the Manual on Uniform Traffic Control Devices (FHWA, 2003).

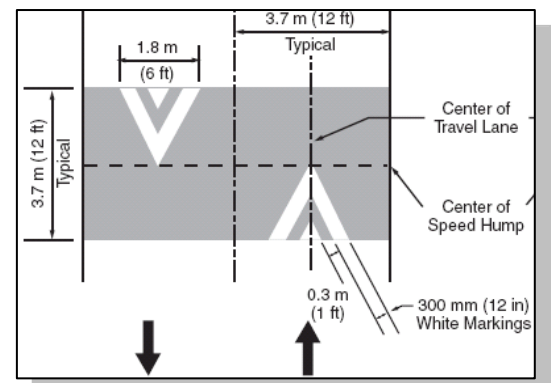

Example: Recommended striping.

COMBINED MEASURES

Some measures from the toolbox can be combined to increase the combined effect on traffic volumes and speeds. For example, a raised crosswalk may be combined with neckdowns, the effect being a crosswalk that is both shortened and raised above the level of the roadway. Motorists must then react to both a vertical deflection and a narrowing. In assessing the suitability of combined measures, the guidelines in Tables 1, 2, and 3 should be applied for both devices.

Sign Dimensions	Color Code		
	Background	Message	Border
30" x 30"	Flourescent Yellow or Yellow-Green	Black	Black

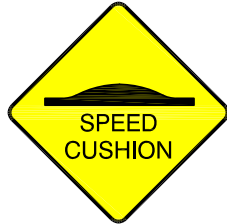

SPEED CUSHION

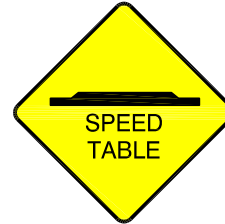

SPEED TABLE



RAISED CROSSWALK

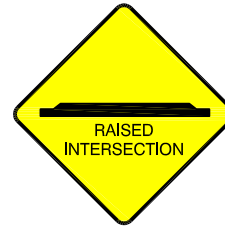

RAISED INTERSECTION

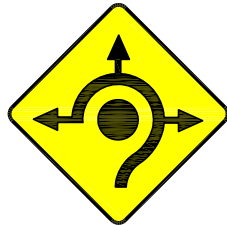

TRAFFIC CIRCLE OR ROUNDABOUT

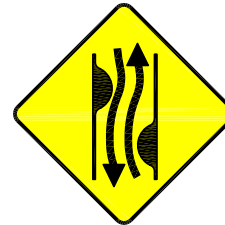

CHICANE

APPENDIX B – STANDARD TRAFFIC CALMING TEMPLATES

Standard neighborhood traffic management device designs are provided for the following measures. Measures that do not have standard designs should be designed according to each situation specific to the roadway and traffic conditions.

<u>Measure</u>	<u>Figure</u>
Speed Hump – Parabolic Profile	B-1A
Speed Hump – Sinusoidal Profile.....	B-1B
Speed Lump	B-2
Speed Table	B-3
Raised Crosswalk.....	B-4
Raised Intersection.....	B-5
Vertical Device – Advance Warning Markings	B-6
Neckdown/Bulbout – Intersection.....	B-7
Neckdown/Bulbout – Midblock	B-8
Center Island Narrowing.....	B-9
Two-lane Choker	B-10
Traffic Circle.....	B-11
Chicane.....	B-12
Partial Closure	B-13
Diagonal Diverter.....	B-14
Median Barrier	B-15
Forced Turn Island.....	B-16

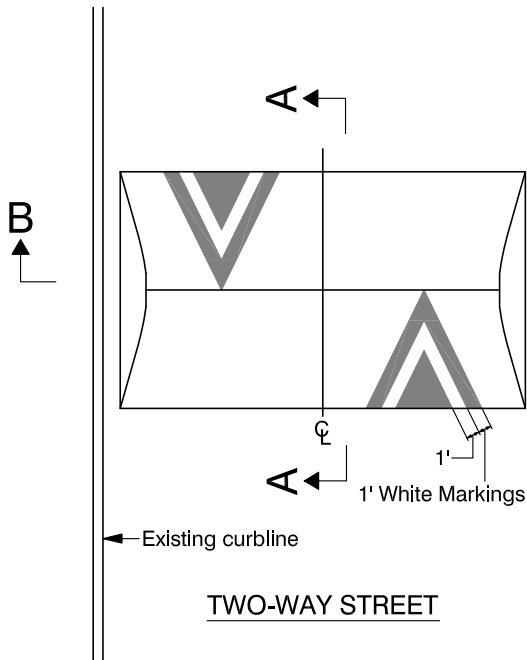

TWO-WAY STREET

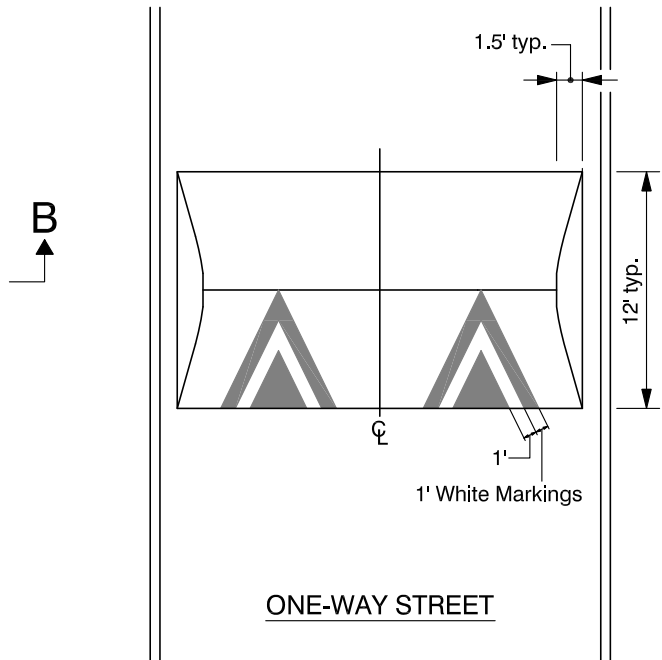

ONE-WAY STREET

Install speed hump warning signs W17-1

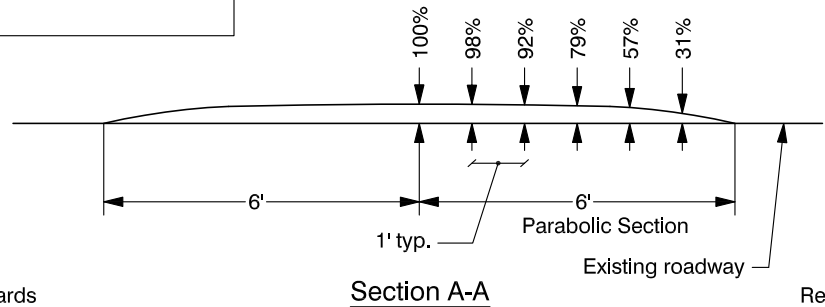

Section A-A

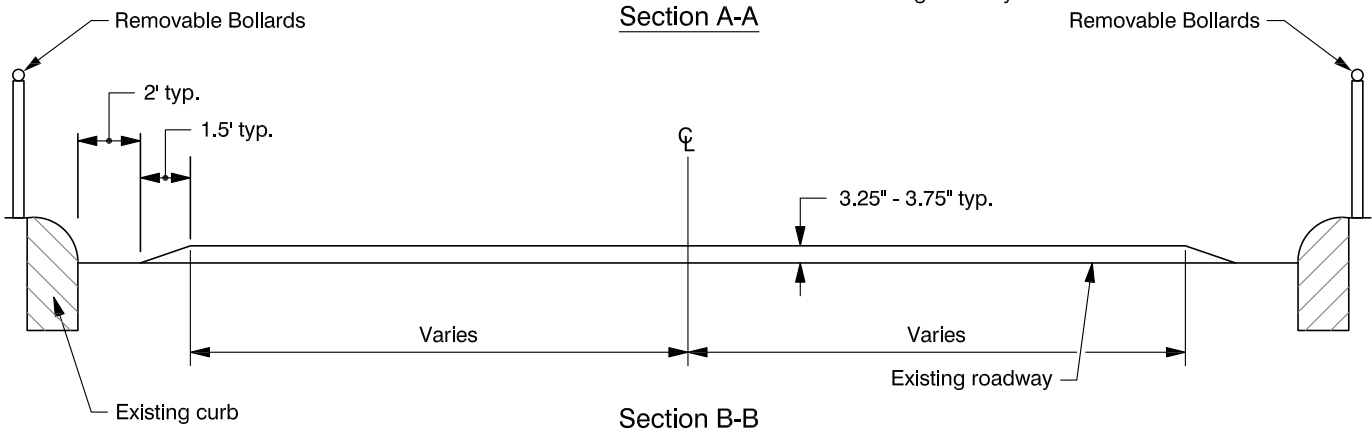

Section B-B

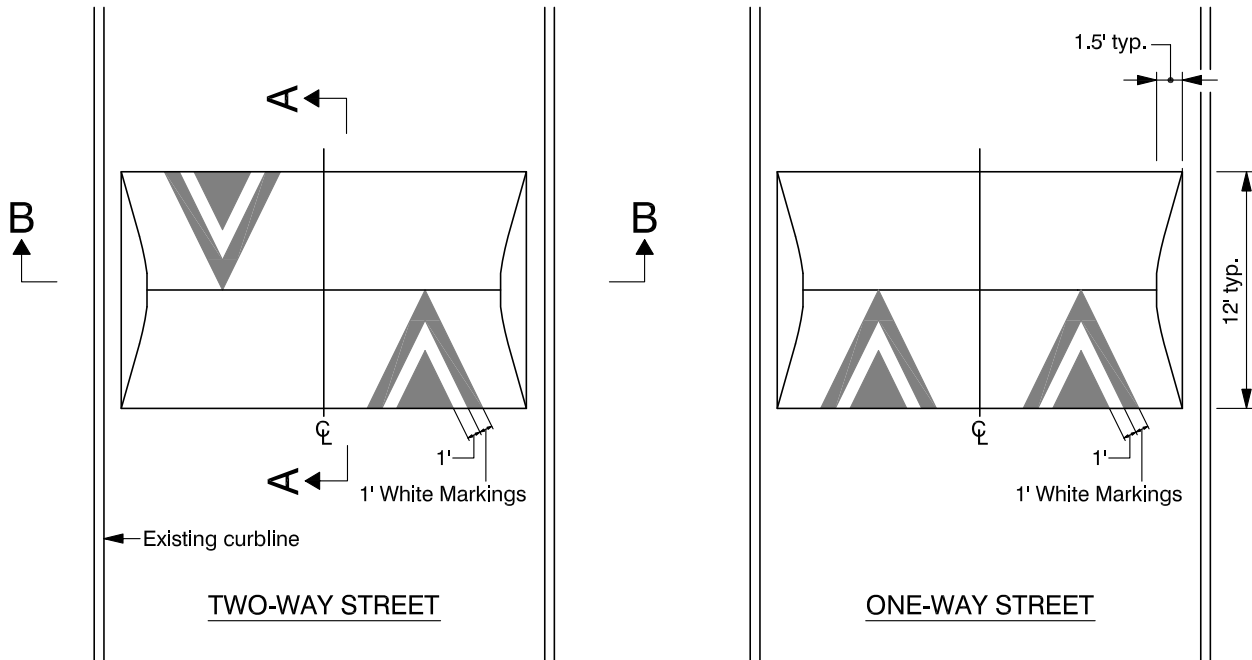

Install speed hump warning signs W17-1

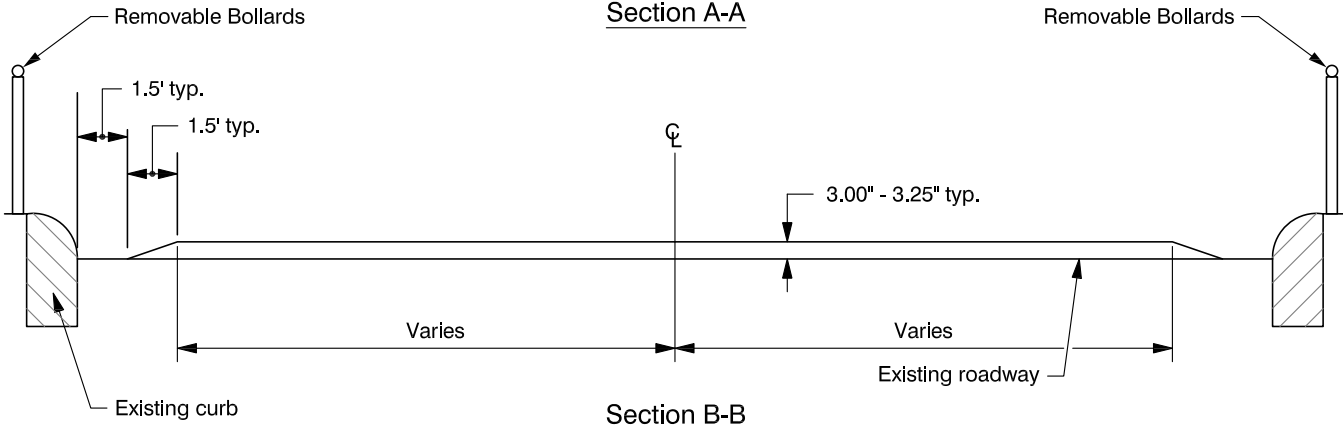
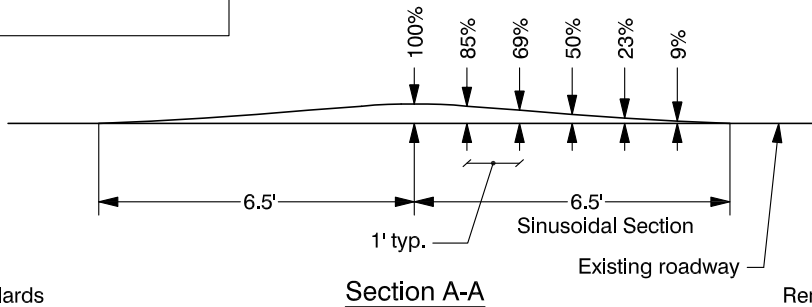

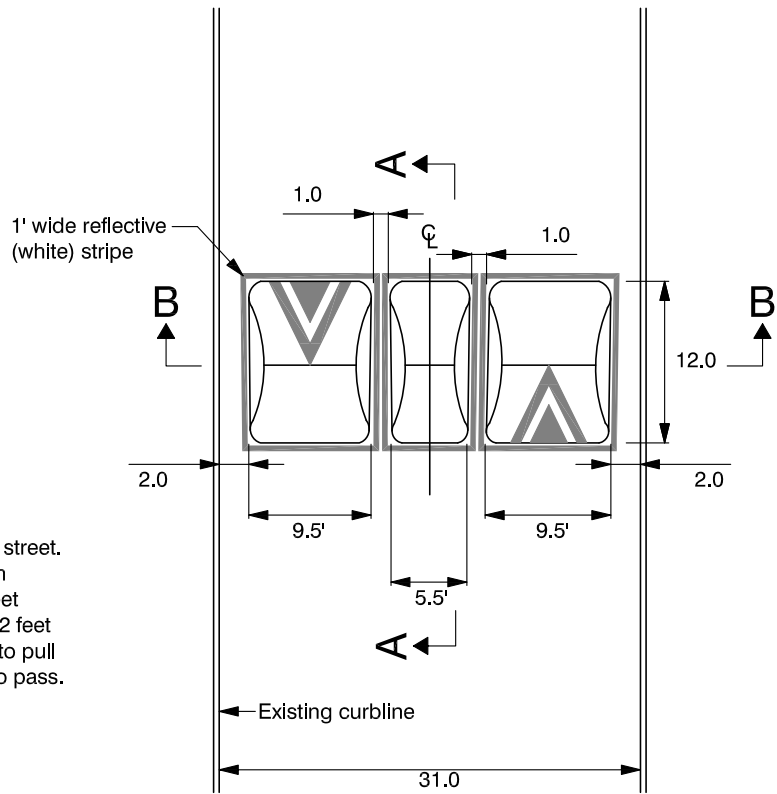
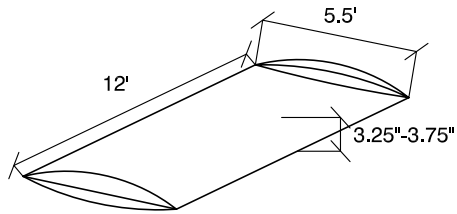

The speed cushion drawing shown is for a 31-foot wide street. If a street is wider, another cushion may be added. Each center cushion (only one shown) is 12 feet deep, 5 1/2 feet wide, 1 foot between outer lumps and center lump and 2 feet from curb & drainage. It may be necessary for vehicles to pull to the right and allow an opposing emergency vehicle to pass.

Install speed cushion warning signs
(See Figure A-3)

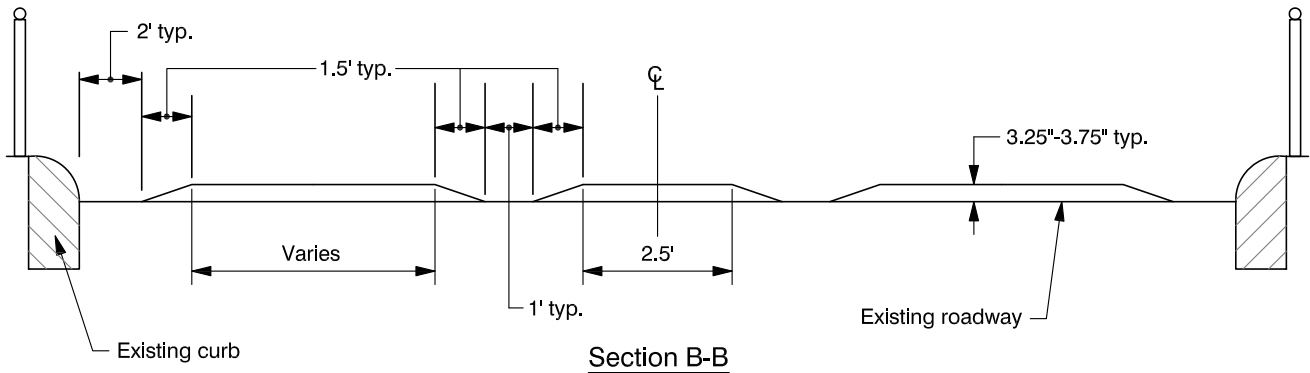
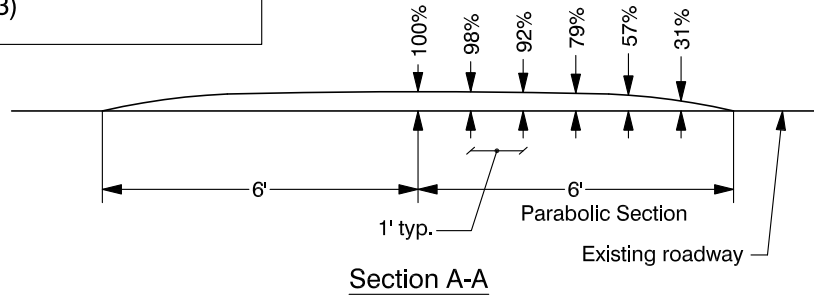

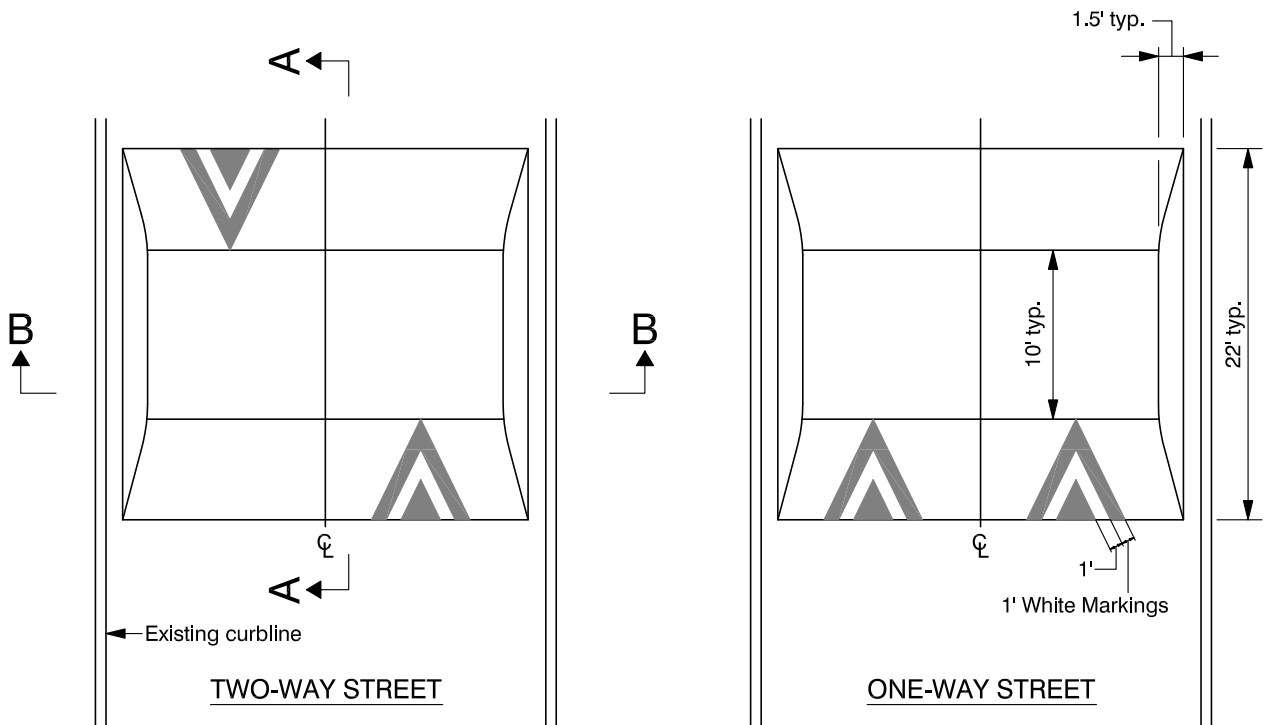

Install speed table warning signs
(See Figure A-3)

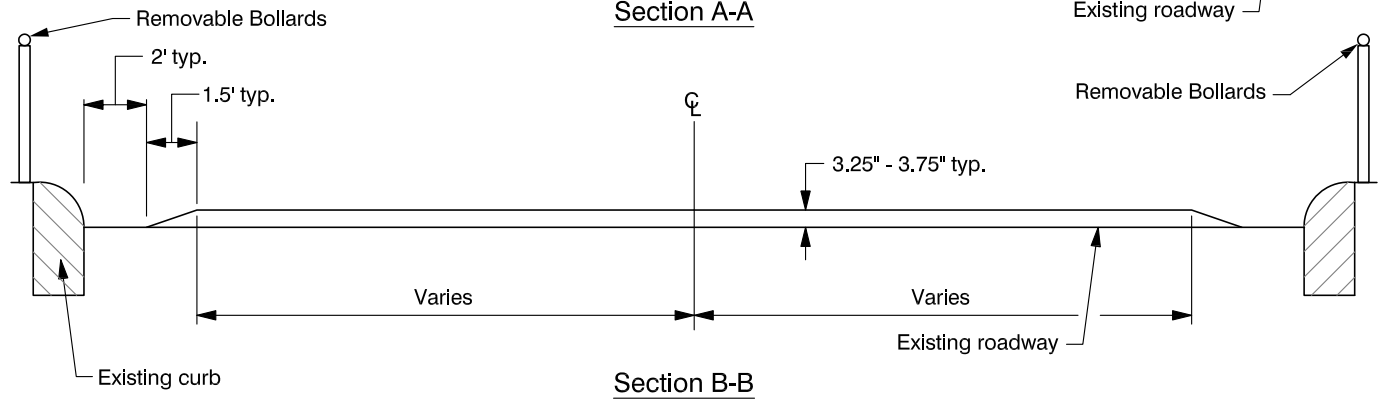
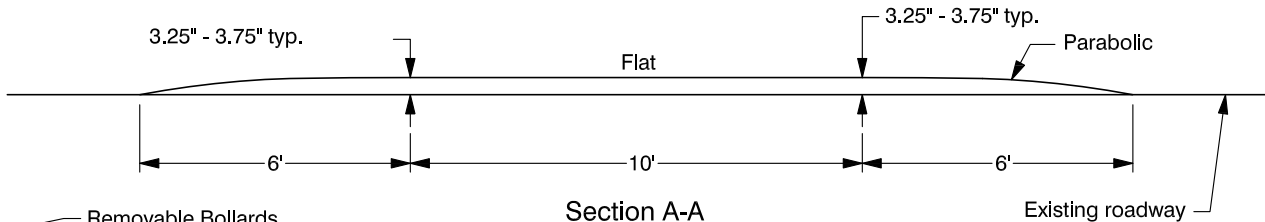
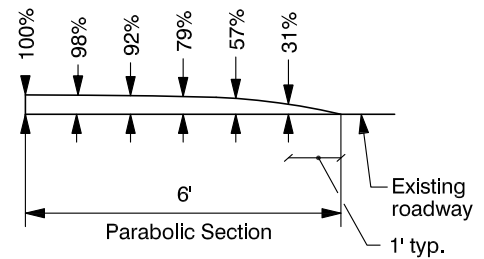

Sign Description
W11-2 Pedestrian Crossing

Inlets are required on the uphill side of a raised crosswalk

Install raised crosswalk warning signs (Shown below)



RAISED CROSSWALK

Sign Dimensions	Color Code		
	Background	Message	Border
30" x 30"	Flourescent Yellow or Yellow-Green	Black	Black

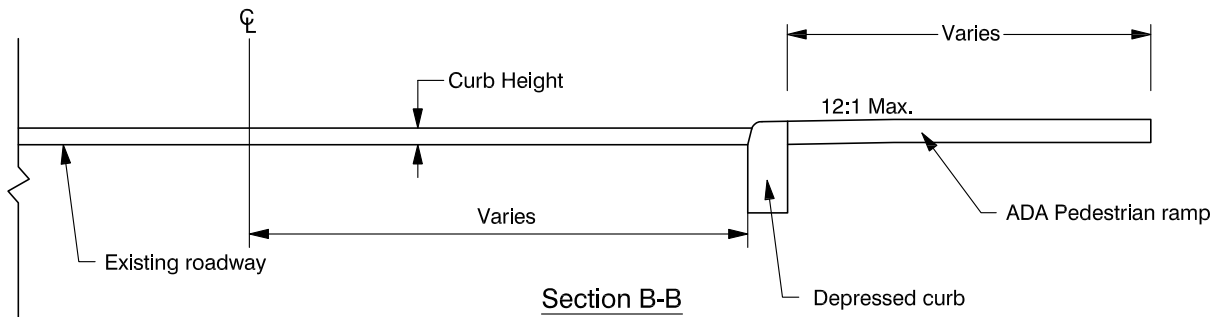
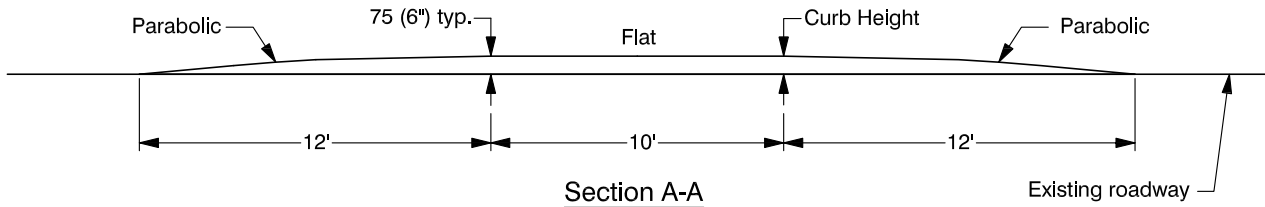
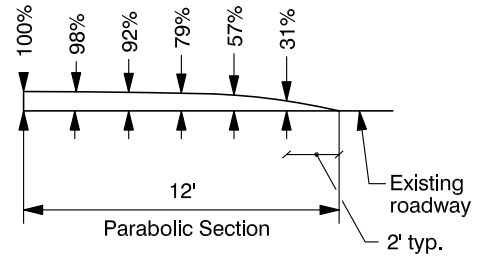
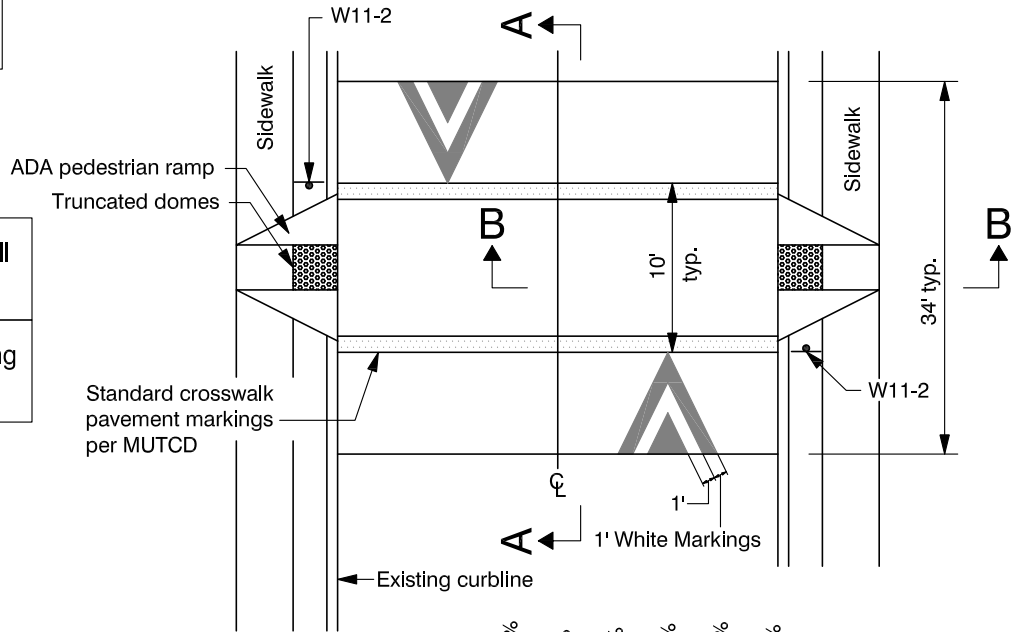

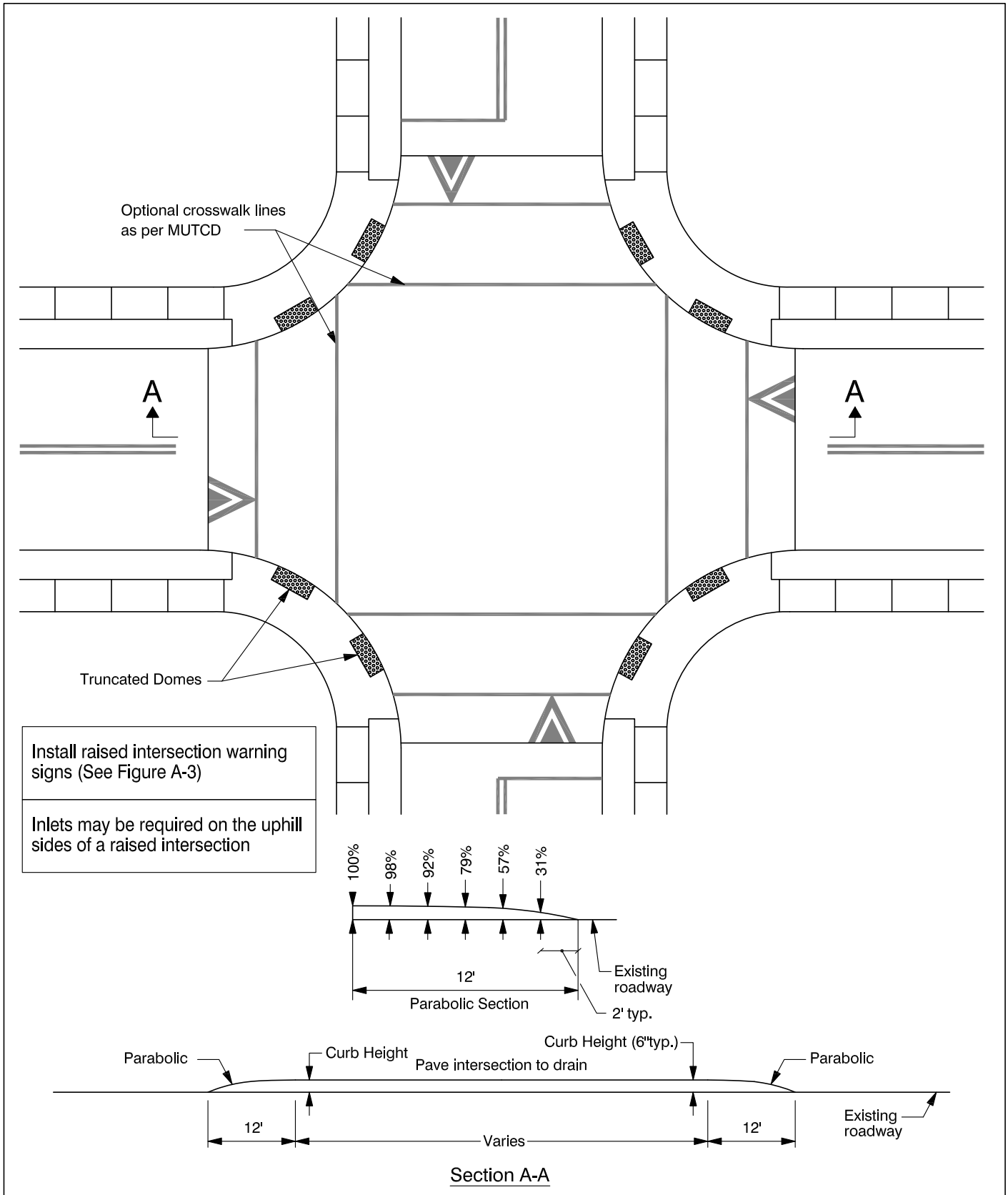

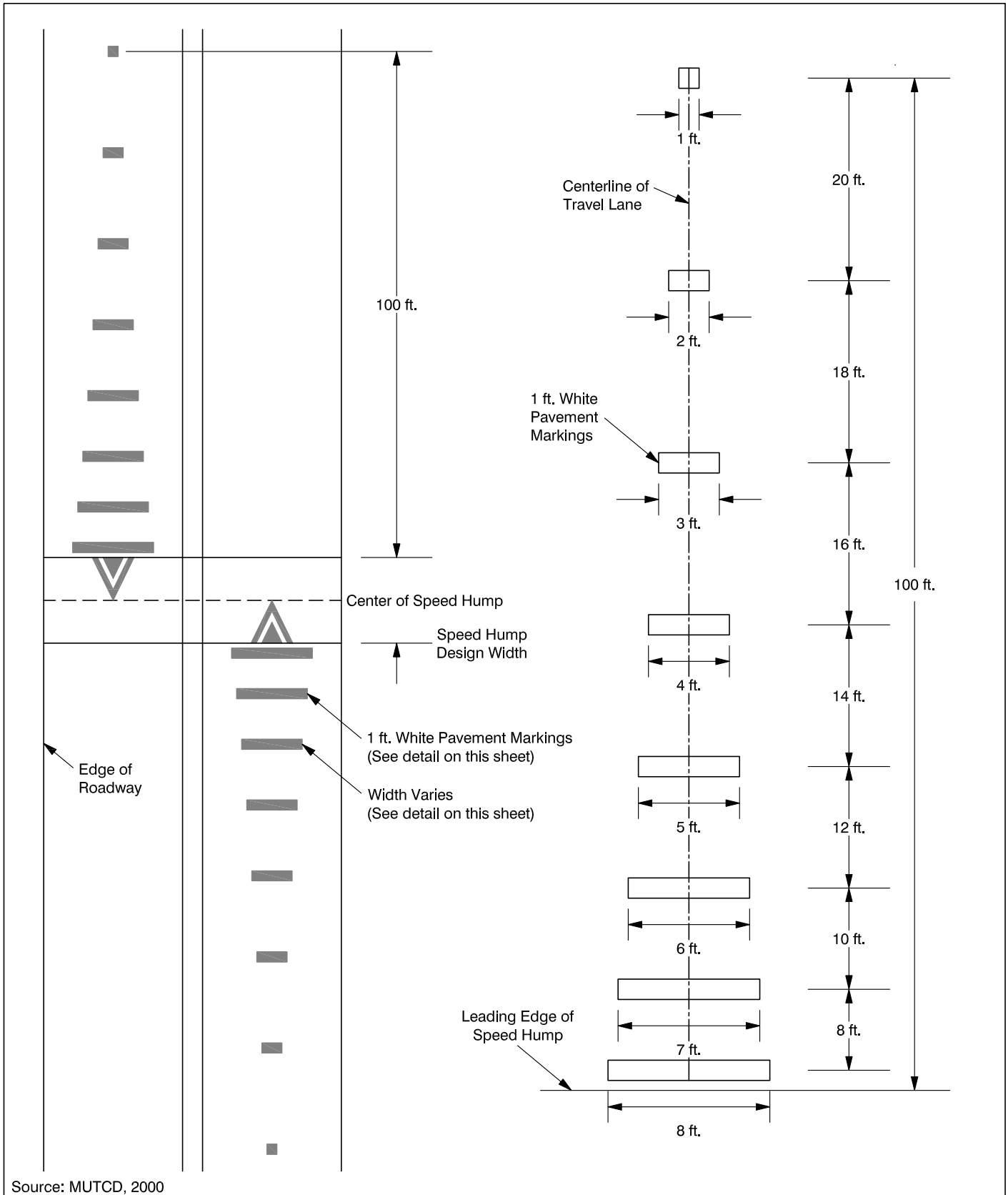

Source: MUTCD, 2000

Sign Description
om Object Marker

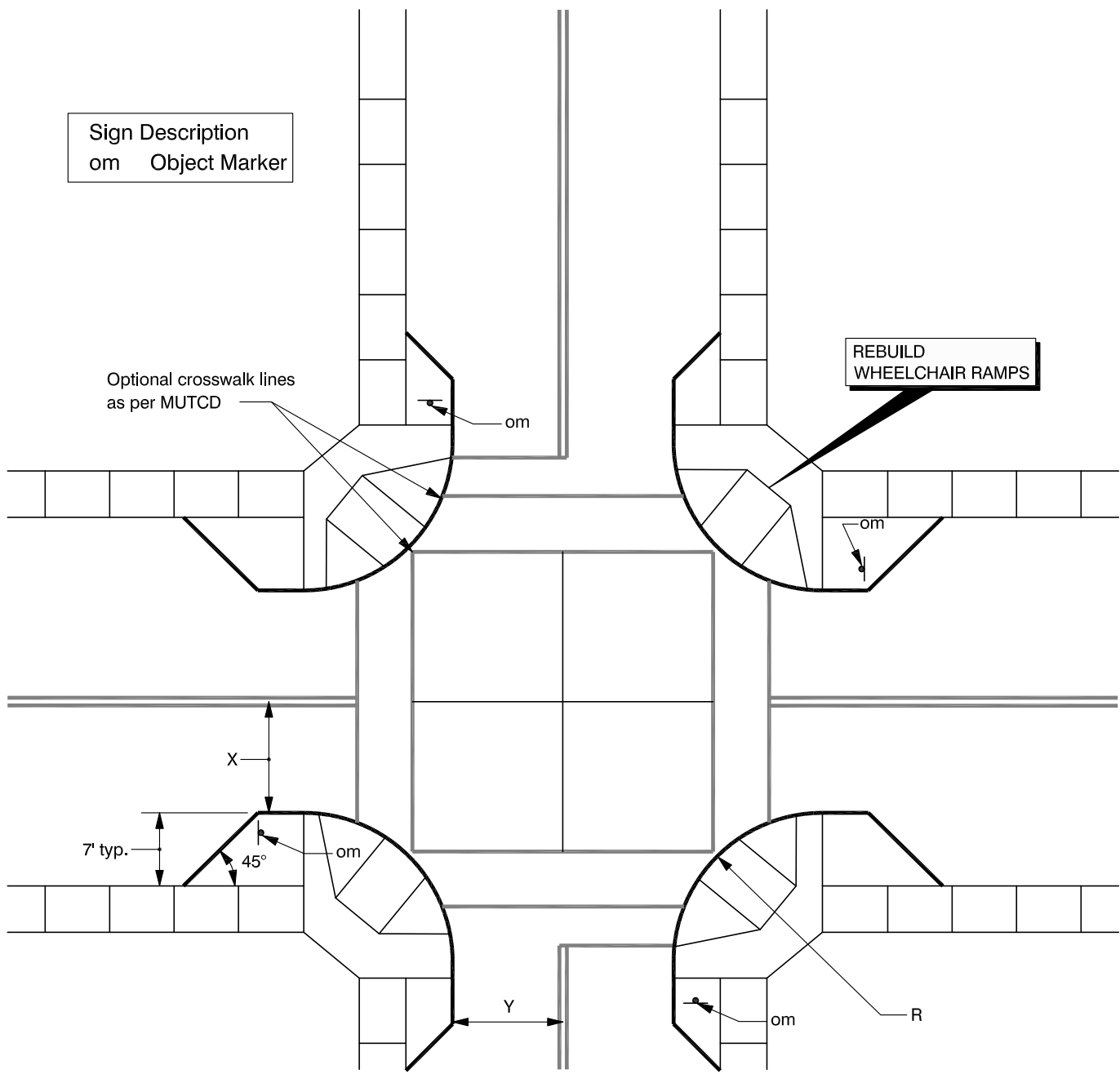

NOTES: 1. Distance X is referenced from the center of the roadway to the lip of gutter.

For The Street Widths:		Use This Curb Radius:
X	Y	R
12'	12'	40'
12'	14'	32'
12'	16'	26'
14'	12'	37'
14'	14'	35'
14'	16'	24'

Sign Description
om Object Marker

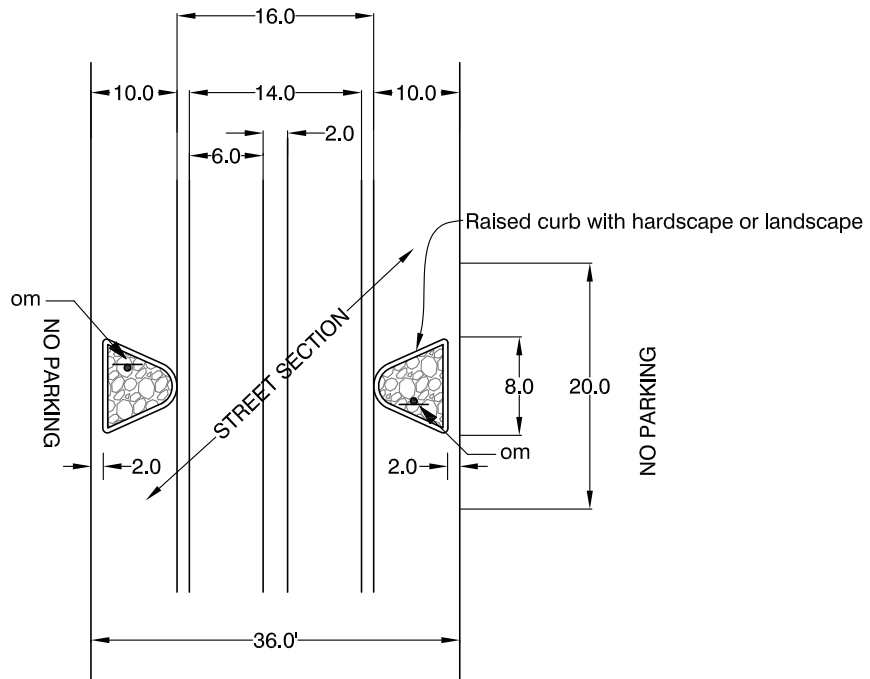

MIN. 36.0' WIDE STREET
FOR WIDER STREETS
MAKE BULB DEEPER

THE BULB-OUT DRAWING SHOWN IS FOR A 36 FOOT WIDE STREET. IF A STREET IS WIDER, THE BULB WOULD BE DEEPER; EACH BULB SHOWN IS EIGHT FEET DEEP SET TWO FEET OFF OF CURB. THE WIDTH BETWEEN BULBS SHOULD BE 16 FEET, WHICH ALLOWS FOR ONE FOOT BETWEEN BULB AND CAR, SIX FEET PER CAR AND TWO FEET BETWEEN CARS. THIS WOULD REQUIRE CARS TO SLOW DOWN SUBSTANTIALLY IN ORDER TO PASS. THE BULB WOULD RESTRICT PARKING FOR APPROXIMATELY 20 FEET (ONE CAR LENGTH FOR PARKING PURPOSES) IN ORDER FOR THE BULB TO BE VISIBLE, ALLOW WIDER VEHICLES TO PULL TO THE RIGHT AND ALLOW AN OPPOSING VEHICLE TO PASS.

NOTE: ON STREETS WITH EDGELINE STRIPING, TAPER EDGELINE PER MUTCD (8:1 MIN TYP.)

Sign Description
R4-7 Keep Right

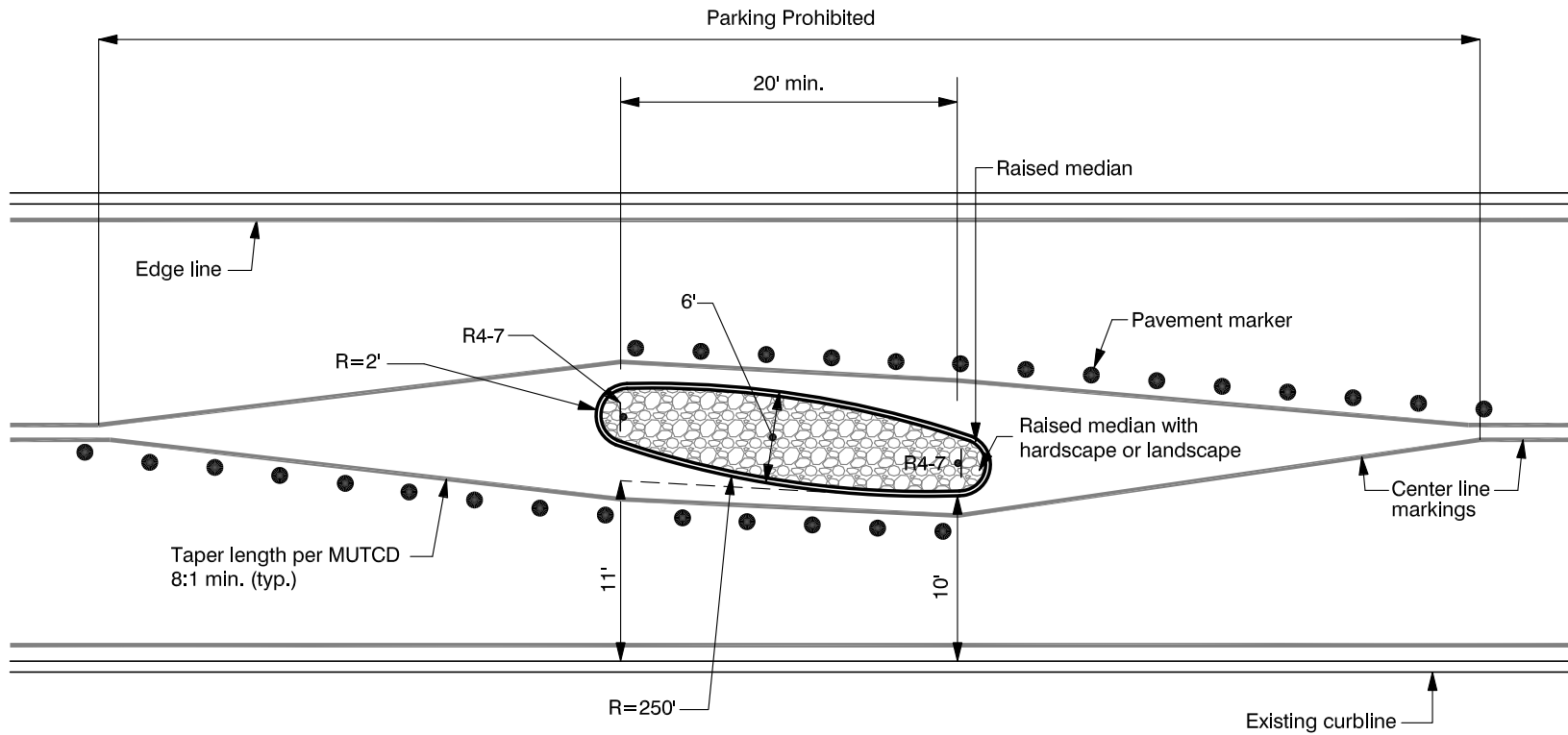

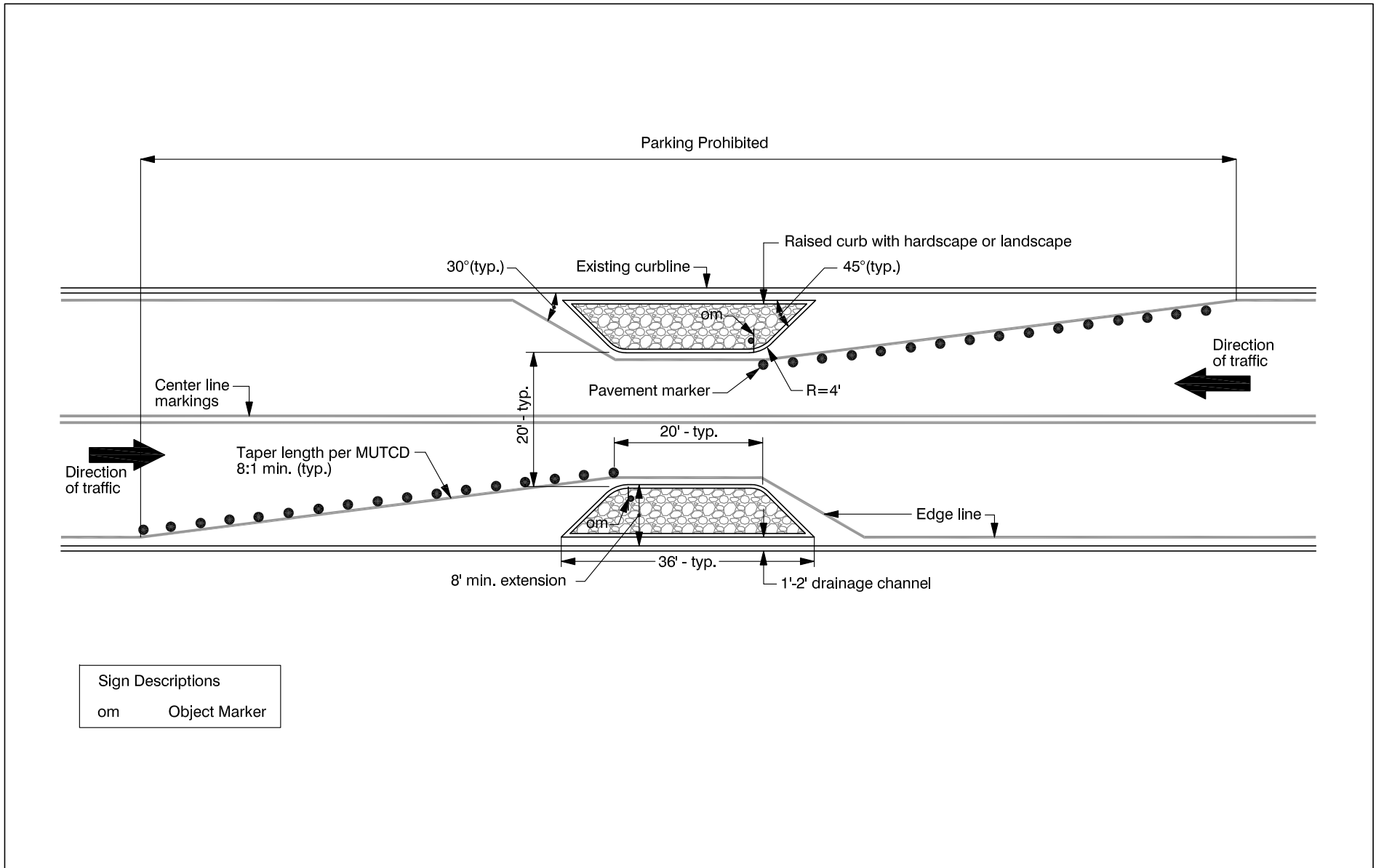

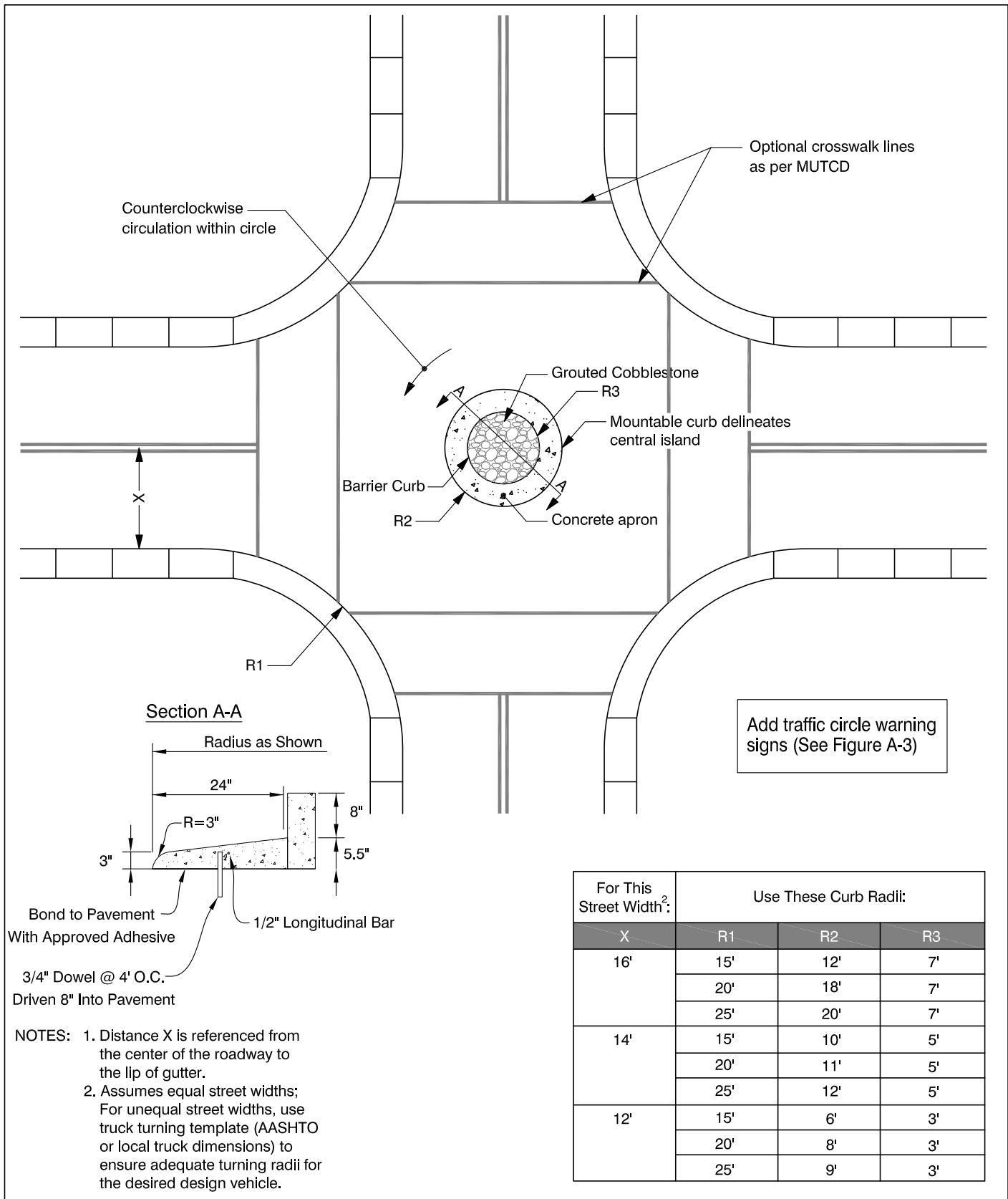

For This Street Width ² :	Use These Curb Radii:		
	X	R1	R2
16'	15'	12'	7'
	20'	18'	7'
	25'	20'	7'
14'	15'	10'	5'
	20'	11'	5'
	25'	12'	5'
12'	15'	6'	3'
	20'	8'	3'
	25'	9'	3'

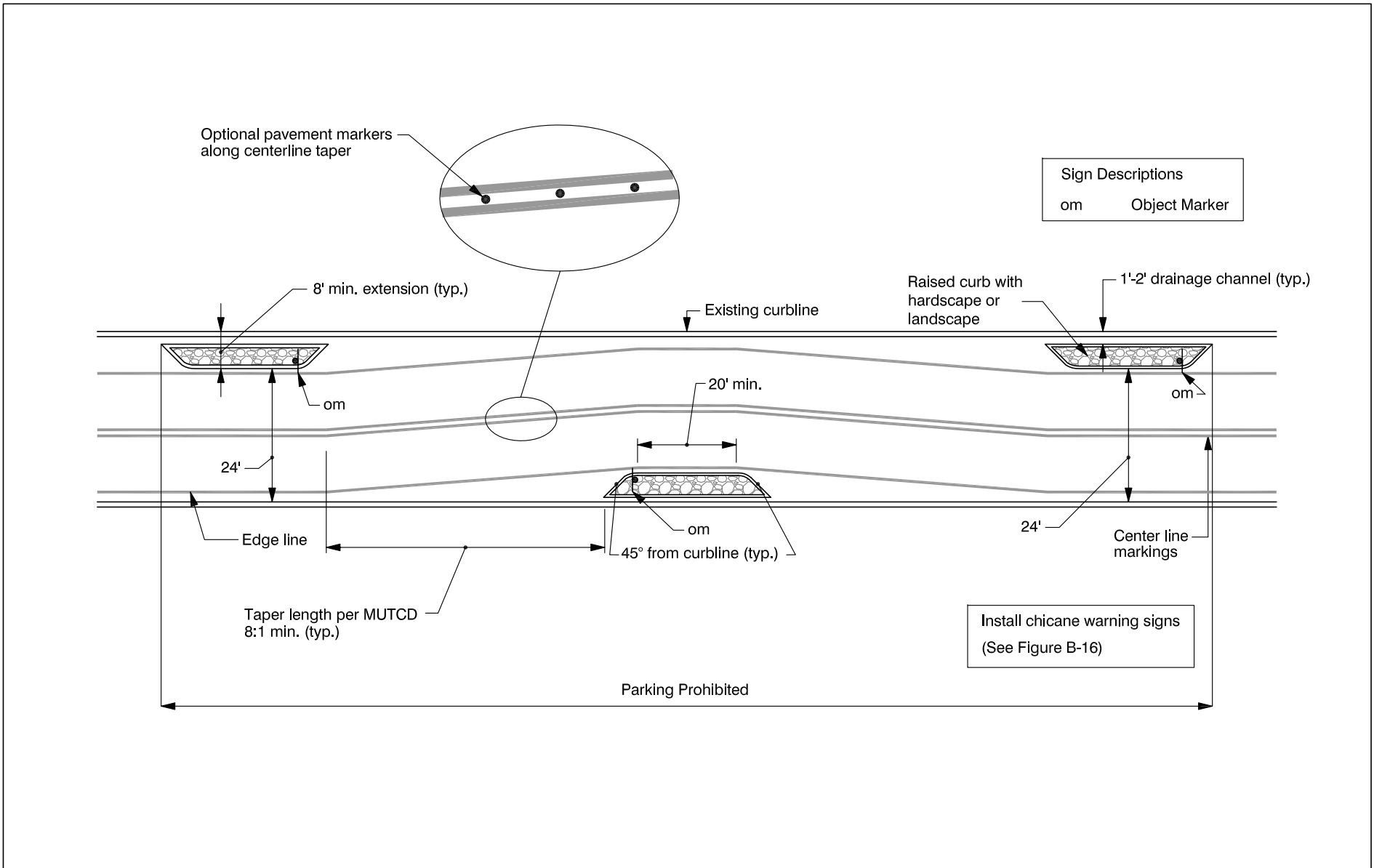

Sign Descriptions

- om Object Marker
- R3-6LR Left or Right Turn
- R5-1 Do Not Enter Except Bikes
- R6-1 One-Way

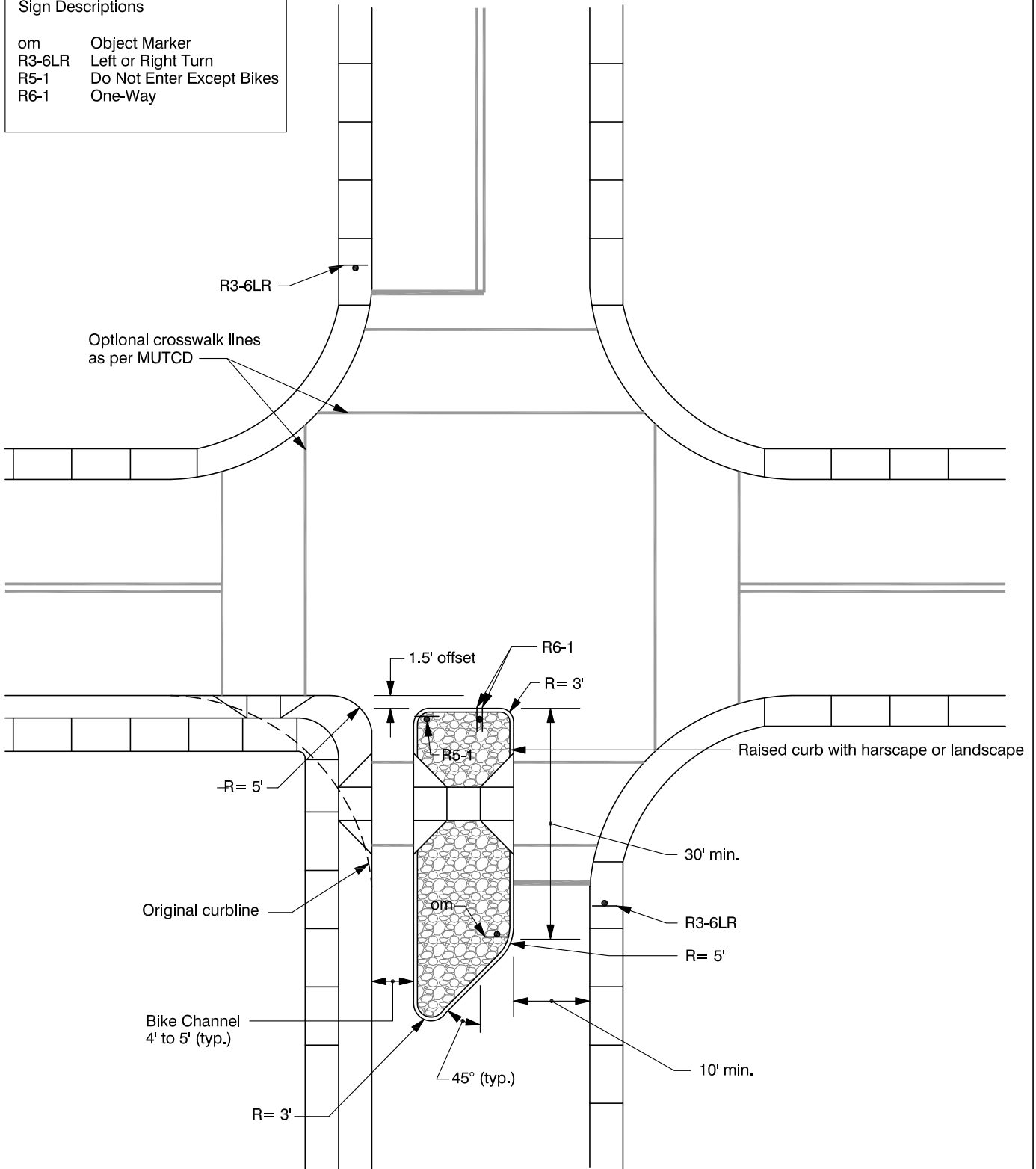

Sign Descriptions

- W1-2L Left Curve
- W1-2R Right Curve
- R7-1 No Parking

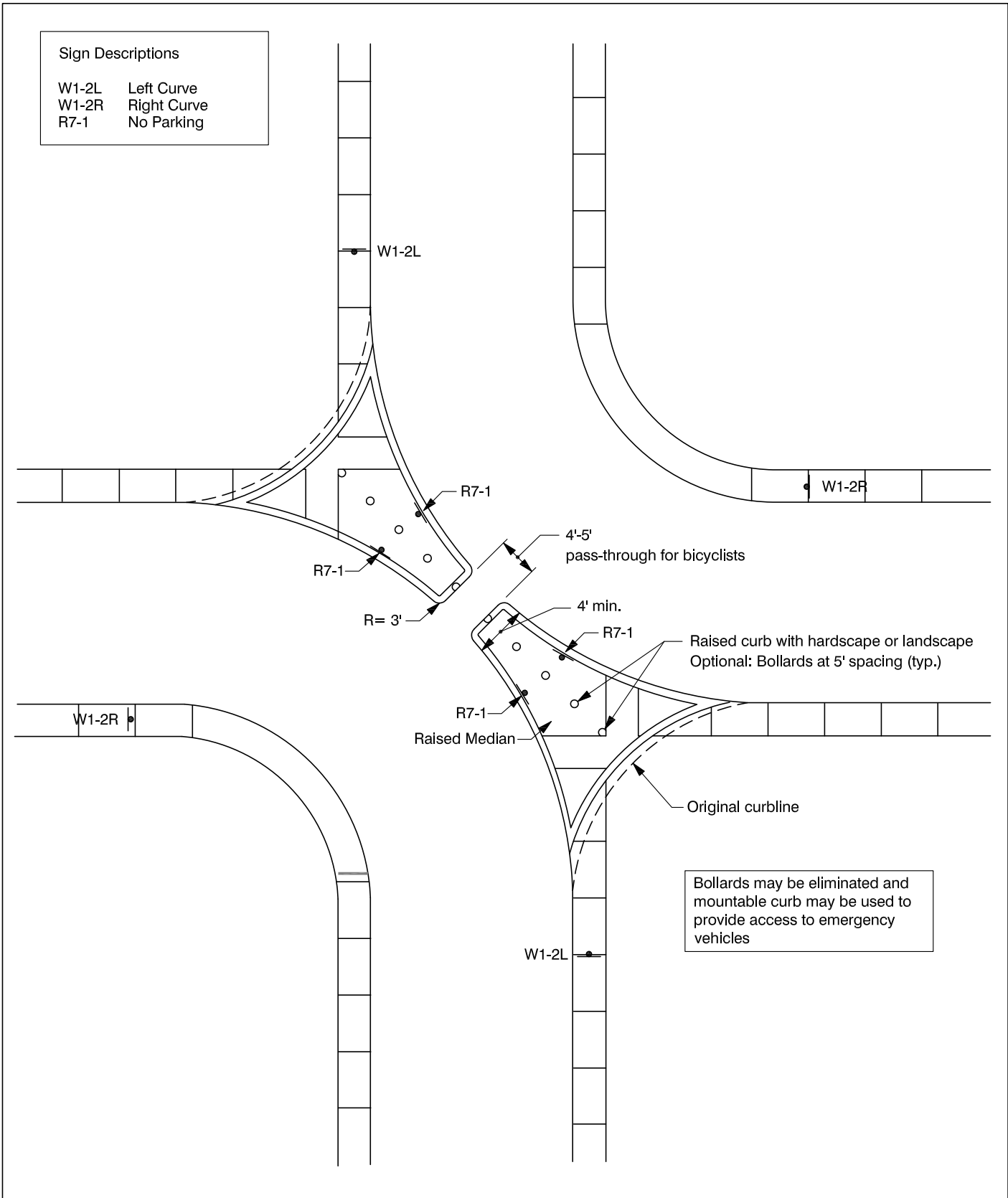

Sign Descriptions	
R6-1	One-Way
R4-7	Keep Right
R7-4	No Stopping or Standing

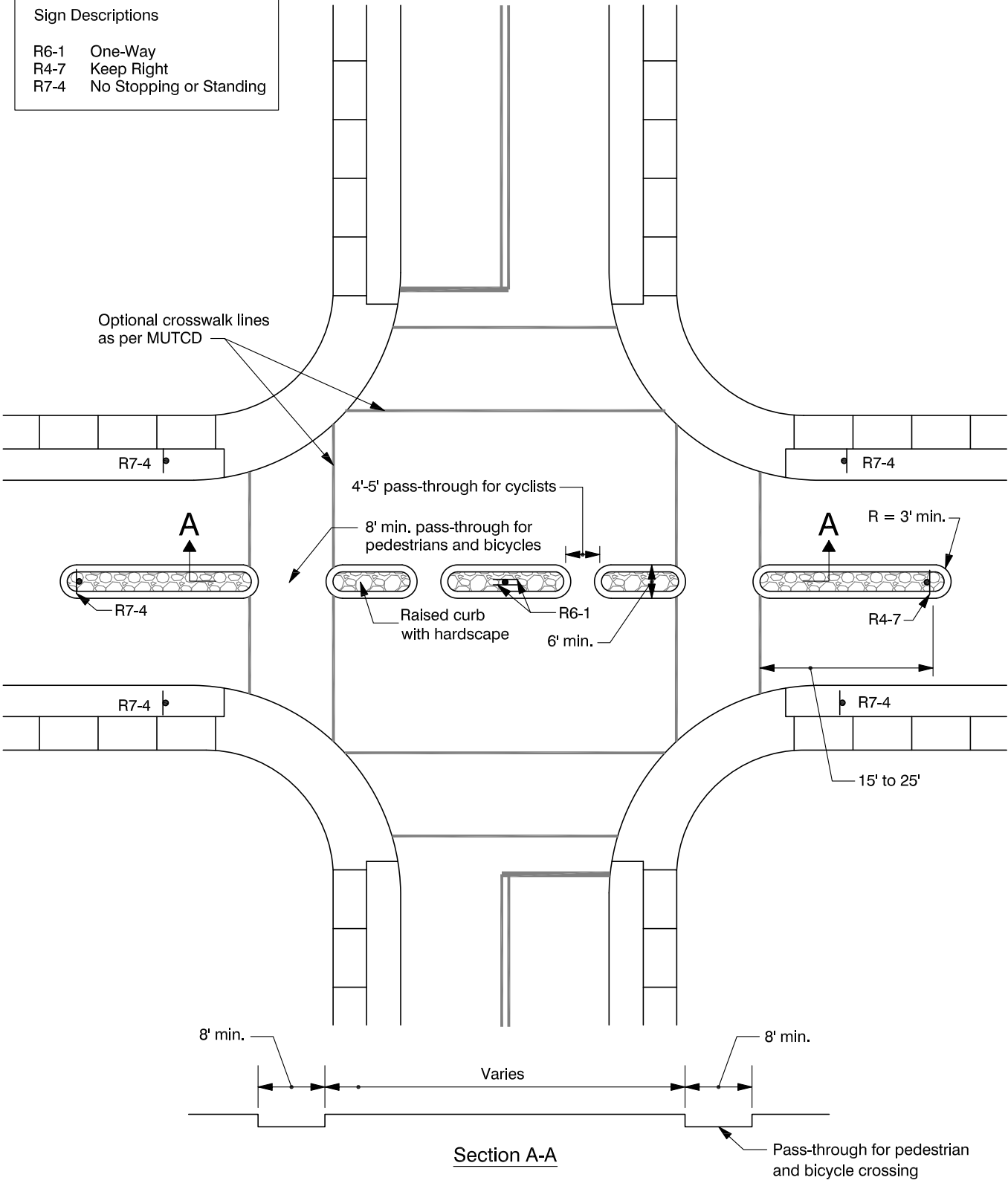

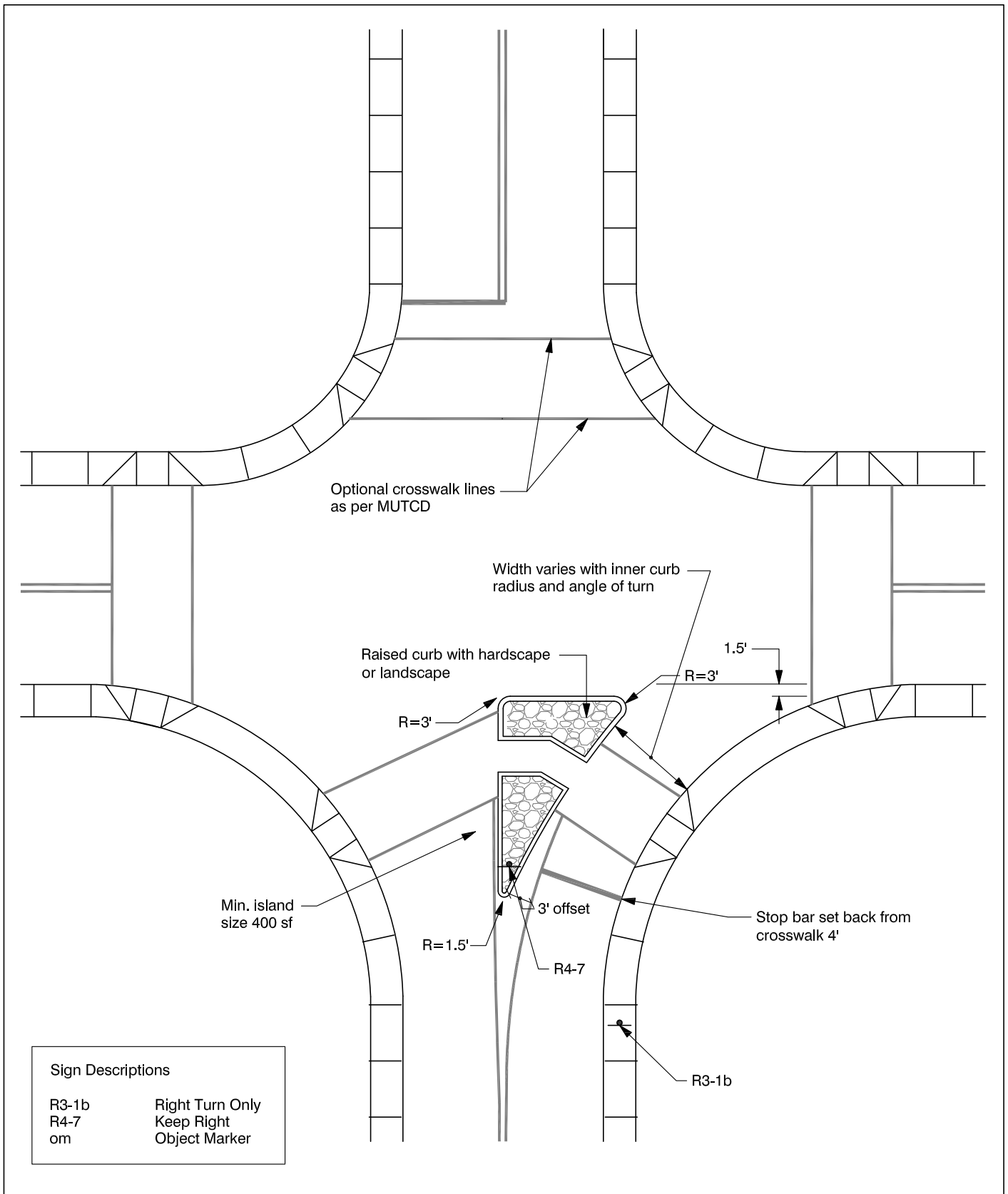

APPENDIX C – CITY OF SALINAS PEDESTRIAN SAFETY ENHANCEMENT DEVICES POLICY

For reference, this appendix presents the City of Salinas Pedestrian Safety Enhancement Devices Policy near schools.

**The City of Salinas
Pedestrian Safety Enhancement Devices Policy**

Policy adopted on _____ . Resolution No. _____

The Manual of Uniform Traffic Control Devices states that “...uniformity means treating similar situations in a similar way. The use of uniform traffic control devices does not, in itself, constitute uniformity. A standard device used where it is not appropriate is as objectionable as a nonstandard device; in fact, this may be worse, because such misuse might result in disrespect at those locations where the device is needed and appropriate.”

To be consistent with appropriate use of traffic control devices and in response to increasing requests for traffic safety enhancements at school locations, the City has approved policy with criteria for when to install Pedestrian Safety Enhancements on City Streets. More specifically, this policy restricts the installation of these enhancements to specific locations at school zones only. The specific safety enhancement installations that are governed by this policy are:

- 1) High visibility crosswalks with an integrated Pedestrian LOOK pavement/sidewalk marking,
- 2) In-Street Pedestrian Crossing Sign

The City of Salinas is committed to the installation of the appropriate and the required traffic control devices on City Streets, including locations along school zones. However, the effectiveness of these and any traffic control device requires an appropriate amount of enforcement for violators of the control devices and appropriate education for users of these devices (motorists, pedestrians and bicyclists). Without appropriate enforcement and education, any installation of traffic control devices will not be as effective.

In response to budget constraints that prevent more frequent enforcement of traffic control devices at school zones, the City will consider the installation of traffic safety enhancements at school zones. This policy will provide the criteria for the use of a High Visibility Crosswalk and an integrated Pedestrian “LOOK” sign at school zones and the In-Street Pedestrian Crossing Sign. These enhancements supports pedestrian crossings at school zones.

- I. **Application.** In order to receive consideration under this policy, an applicant must submit a written request to the **City of Salinas Development and Engineering Services Department, ATTN: Traffic Section, 200 Lincoln Avenue, Salinas, California 93901**. A letter from the School and the School District must accompany the request stating the school’s and the district’s concurrence with the request.

II. **Consideration.** Effective on the adoption of this policy, requests for High Visibility Crosswalks and the integrated Pedestrian LOOK Sign shall be subject to the following criteria:

1. School Zone Criteria. Said Pedestrian Safety Enhancement Devices will be located at an existing school crosswalk adjacent to the school property, and along the suggested route to school; and
2. No installations at Controlled Intersections. Said Pedestrian Safety Enhancement Devices shall not be installed at intersections where ALL WAY STOPS or a Traffic Signal is already present; and
3. Installation only on two lane streets. Said Pedestrian Safety Enhancement Devices shall only be installed on two-lane streets. (Existing studies support installation on two-lane streets but results are mixed on multi-lane streets. It is not clear if these crosswalks increase yielding of motor vehicles to pedestrians on multi-lane streets); and
4. School Pedestrian Warrant.
 - a) At least 40 school pedestrians are crossing the uncontrolled street during each of any two hours (not necessarily consecutive) of a normal school day; and
 - b) The vehicle volume through the crossing exceeds 500 vehicles per hour during the same hour the students are going to and/or from school during normal school hours; or
 - c) The number of pedestrians that are crossing the uncontrolled street in 4.a multiplied by the vehicle volume through the crossing during the same hour students are going to and/or from school during normal school hours exceeds 32,000.

This Policy provides a technically-based and uniform process for the recommendation of the above Pedestrian Safety Enhancements. However, each location requested for high visibility crosswalk will have its unique characteristics that may not be addressed by these criteria. Other criteria that may have to be considered include unique street configuration, sight visibility requirements, other heavy uses of the street that are not school related, and other equally important considerations.

The decision to use a particular traffic control device at a particular location should be made on the basis of either an engineering study or the application of engineering judgment. Thus while the MUTCD, the California Supplement or this Policy provides standards, guidance or options for design and application of a traffic control device, the MUTCD, California Supplement or this Policy should not be considered a substitute for sound engineering judgment.

At the City Engineer's discretion, traffic studies may be conducted to examine other considerations not part of this Policy's criteria. Results of these studies may become the basis to support or oppose recommendation resulting from previously considered criteria.

- III. **Commission Consideration** City staff will bring its recommendation to the Traffic and Transportation Commission (T&TC). The meeting of the T&TC provides a public forum for the applicant or any impacted party to support or protest City staff's recommendation. The Traffic and Transportation Commission may recommend approval or denial of the applicant's request based on the criteria above for these Pedestrian Safety Enhancement Devices.

- IV. **Council Consideration.** The City Council makes the final decision regarding the request for a school high visibility crosswalk. The meeting of the City Council provides another public forum to appeal decisions of the T&TC made following the application of this policy.



APPENDIX D – CITY OF SALINAS PRIMARY FIRE RESPONSE ROUTES

For reference, this appendix presents the City of Salinas Primary Fire Response Routes figure.

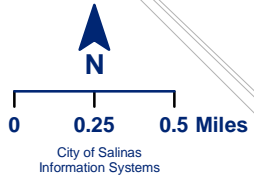

City of Salinas Primary Fire Response Routes

- Major Arterial
- Minor Arterial
- Collector
- Salinas City Limits